

FREEDOM4®

Portable Restroom Assembly Instructions



2530 Xenium Lane North, Minneapolis, MN 55441
Telephone: 763-553-1900 Fax: 763-553-1905
800-328-3332 / www.satelliteindustries.com



PN 23870



PN 20903

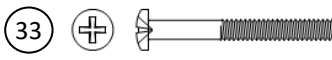

PN 40052

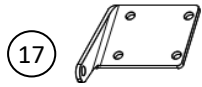

PN 21382



PN 16307



PN 18813

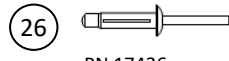

PN 17436



PN 18718



PN 22536



PN 22310

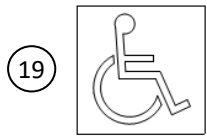

PN 10394



PN 11054



PN 11315



PN 11270

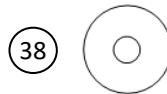

PN 22584

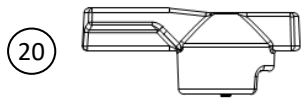

PN 40057

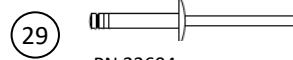

PN 22604

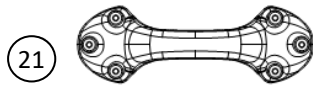

PN 22522

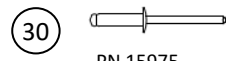

PN 15975

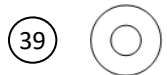

PN 12382

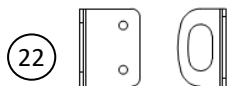

PN 22605

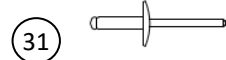

PN 22543



PN 13131



PN 13860



PN 11360

HDWE, FREEDOM4 (22540)

ITEM	PART#	QTY	DESCRIPTION
40	11360	31	WASHER, ¼ ID FENDER STNLS
39	12382	25	WASHER, ¼ FLAT STNLS
38	22584	12	WASHER, 5/16 ID FENDER HD SS
37	11315	92	WASHER, 3/16 RIVET STNLS
36	22310	1	SPINDLE, PRGRD II 3 ROLL METAL
35	18718	24	SCREW, ¼-20 X 1 TRUSS HEAD
34	18813	5	SCREW, #10-24 X ¾ TRUSS STNLS
33	40052	1	SCREW, ¼-20X3-1/2 PH PNHD SS
32	13860	6	SCREW, 14 X 1-1/2 W/WSH GOLD
31	22543	29	RIVET, #610 AAL POP
30	15975	2	RIVET, #66 STNLS
29	22604	54	RIVET- TRI-LOBE X 5/8 LF
28	11270	4	RIVET, #68 STNLS
27	11054	57	RIVET, #68 AAL POP
26	17436	5	RIVET, AVDEL SILVER
25	16307	25	NUT- ¼-20 NYLOC STNLS
24	20903	1	NUT- #10-24 NYLOC
23	13131	6	NUT, 5/16 NYLOC
22	22605	2	HASP-LARGE LOCK EXTENDED
21	22522	6	HANDLE, PLASTIC LIFT DGRY
20	40057	1	HANDLE, GB TOILET GREY
19	10394	1	DECAL, HCP (ISA) FREEDOM2
18	22536	1	CLOSURE, DOOR HYDRAULIC 1X16
17	21382	1	BRACKET, FREEDOM3 CLOSURE
16	23870	6	BOLT- 5/16-18 X 1-1/4 HXHD STNLS

ITEM	PART#	QTY	DESCRIPTION
15	13796	1	VENT PIPE, 3 X 65-1/2 BLACK
14	22537	2	TUBE- FREEDOM4 STIFFENER BLK
13	22608	1	TANK, FRE/LIB 35 GAL BLOWMOLD
12	16538	1	TANK, FRE/LIB LARGE DGRY
11	10570	1	SEAT- TOILET TUF/FRE/LIB BLACK
10	22518	1	ROOF- FREEDOM4 NATURAL
9	22209	1	HOOD- PAPERGRD 3 ROLL DGRY
8	22540	1	HDWE, FREEDOM4
7	22519	2	GRAB BAR- LIB/FRDM4 PLASTIC
6	22520	1	FLOOR- FREEDOM4
5	22535	1	DESIGN- PANEL HALF RIGHT FRDM4
4	22534	1	DESIGN- PANEL HALF LEFT FRDM4
3	22517	3	DESIGN- LIBERTY/FR4 SIDE PANEL
2	22516	1	DESIGN- FREEDOM4 FRONT ASSY
1	22523	1	COVER- FREEDOM4 DOOR CLOSER

INTRODUCTION

Satellite portable restrooms must be assembled according to approved assembly procedures. Avoid variations in assembly procedures which could adversely affect product life and warranty.

All references to front, left, right, and rear are looking at the door of the unit from the outside.

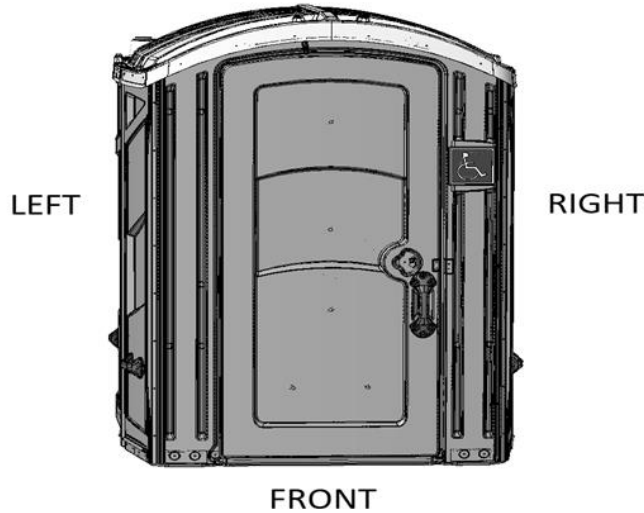

Tools:

•Standard screwdriver	•Drill Electric or Cordless Drill	•# 2 Phillips Head Driver Bit	•3/8" (.375") [9.53 mm] Hex Driver bit
•Pop Rivet Gun	•#10 (.193") [5 mm] Drill bit	•# 3 Phillips Head Driver Bit	•5/16" (.312") [7.64 mm] drill bit
•1/2" (.500") [12.2 mm] Open end wrench	• 1/2" (.500") [12.2 mm] socket or socket driver bit	•1/4" (.250") [6 mm] Drill bit	•7/16" (.437") [11.1 mm] socket or socket driver bit
		• Adjustable wrench	

REMEMBER:

- A minimum of 2 workers are required to assemble this restroom. 
- KEEP PARTS ORGANIZED.** Open only enough kit boxes for the number of toilets you can assemble in an hour.
- Staging parts will minimize assembly time.
- ASSEMBLY AREA MUST BE LEVEL, FLAT & FREE OF DEBRIS. A PAVED SURFACE IS BEST.**
(This insures that the restroom is square & true.)

Rivet large panels (left / right / rear) together in rear corners:

1) Rivet panels (left / right / rear) together in rear corners. Left corner (rear panel overlaps left side panel). Right corner (right side panel overlaps rear panel).



2) Use (8) rivets P/N 11054 & (8) washers P/N 11315 per corner. Rivet from outside to inside of unit with washer placed inside.



Rivet rear and side large panels to floor:

3) Rivet left, rear, and right panels to floor. Position panels on outside of floor with floor lip fitted in channel near bottom of panels. Align panel holes with holes in floor. Install (7 per panel) rivets P/N 22543 from inside unit through holes in floor and holes in panel. Place (7 per panel) washers P/N 11315 onto rivets on outside of unit.

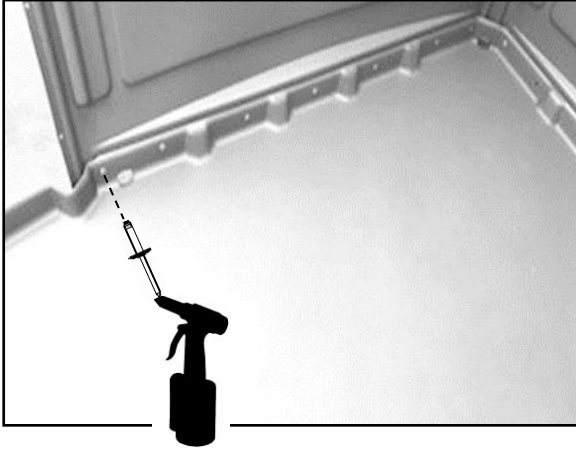

NOTE: FLOOR LIP MUST BE FULLY ENGAGED WITH PANEL CHANNEL

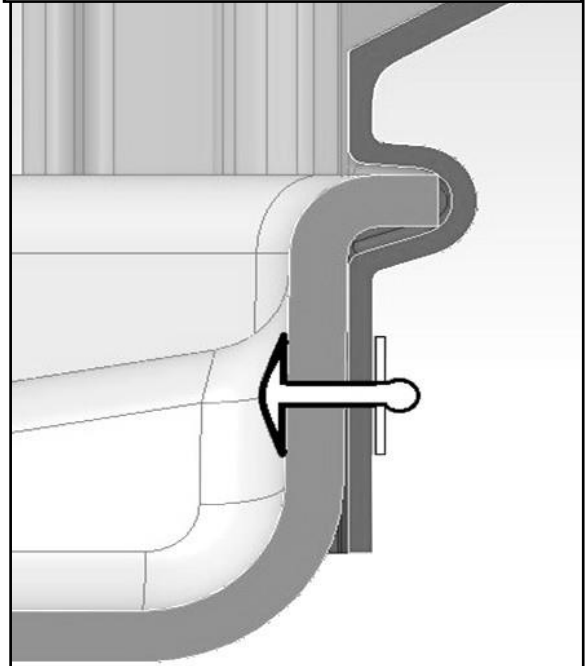

Install lift handles on Half panels:

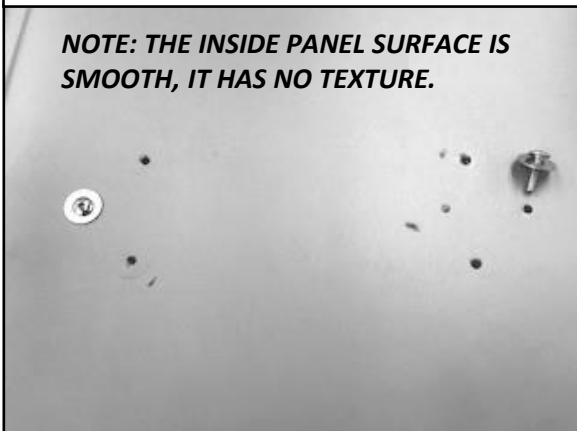

4) Use (6) screws PN 18718 with (6) washers PN 11360 on inside of half panel, through 6 pre-drilled holes in half panel for mounting lift handle.





5) Place lift handle PN 22522 on outside of panel with screws PN 18718 through holes in handle. Install (6) washers PN 12382 & (6) nuts PN 16307 on screws using # 3 Phillips Bit & 7/16" (.437") [11.1 mm] socket. **Repeat steps 4 & 5 for next half panel.**



Rivet half panels to floor:

<p>6) Rivet left half panel to floor. Position panel on outside of floor so floor lip fits in bottom channel in panel. Holes in panel align with holes in floor.</p>	<p>7) Install (4) rivets P/N 22543 from inside unit through holes in floor and panel. Place (4) washers P/N 11315 onto rivets outside of unit.</p>	<p>8) Repeat steps 6) & 7) riveting right half panel to floor. NOTE: FLOOR LIP MUST BE FULLY ENGAGED WITH PANEL CHANNEL</p>
		

Rivet Half Panels to side Panel & Stiffener Tube:



<p>9) Position the Left half panel to left side panel (<i>left side panel overlaps left half panel</i>).</p>	<p>10) Place stiffener tube PN 22537 on outside of unit where panels are joined, align bottom panel hole with bottom stiffener tube hole. NOTE: START WITH BOTTOM HOLE. PANELS & TUBES MUST BE FIRMLY PRESSED TOGETHER AT EACH RIVET LOCATION.</p>	<p>11) Install (1) rivet P/N 22604 from inside unit through bottom panel hole into bottom stiffener tube hole. Install remaining (7) rivets PN 22604. Note: Hold Rivet-gun square to surface being riveted. Press stiffener tube firmly against panels. Repeat steps 10 & 11 on right half panel.</p>
		
<p>NOTE: INSPECT TUBE INSTALLATION TO MAKE SURE ALL RIVETS ARE GRIPPING AND INSTALLED PROPERLY</p>		

Install lift handles on side panels:

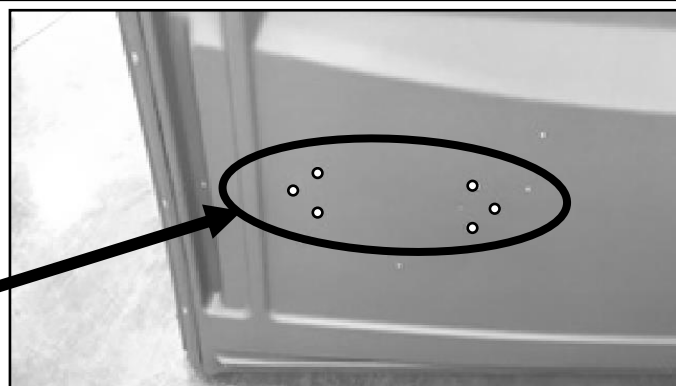

12) Drill at 6 dimple locations near rear corners of left & right side panels using a 1/4" (.250") [6,35 mm] Drill bit.



Install lift handles on side panels *continued*:

<p>13) Use (6) screws PN 18718 with (6) washers PN 11360 on inside of side panel, through 6 holes in side panel for mounting lift handle.</p>	<p>14) Place lift handle PN 22522 on outside of panel with screws PN 18718 through holes in handle. Install (6) washer PN 12382 & (6) nuts PN 16307 on screws using # 3 Phillips Head Driver Bit & 7/16" (.437") [11.1 mm] socket or socket driver bit.</p>
	

Install paperguard:

<p>15) Drill out 4 marks ("O") in left panel from inside unit using a drill with a 1/4" (.250") [6 mm] drill bit, at location shown below.</p>	<p>16) Install paperguard PN 22209 with (4) rivets PN 11054 outside of panel and (4) washers PN 11315 inside of unit on rivet.</p>	<p>17) Insert the spindle PN 22310 into the paperguard. Note: position of the hook.</p>
		



Install "Large Tank option PN 16538" and Vent pipe:

18) Install the seat lid PN 10570 (*comes with plastic bolts & nuts*) on the tank PN 16538. Install the Plastic bolt through the seat lid hinge into the tank. Thread the plastic nut on the bolt from inside of tank. Place the tank in left rear corner of the restroom.

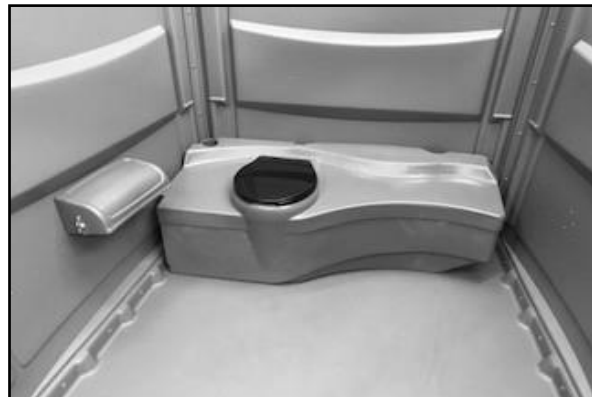

WARNING: DO NOT OVERTIGHTEN THE PLASTIC NUTS, THEY WILL BREAK.



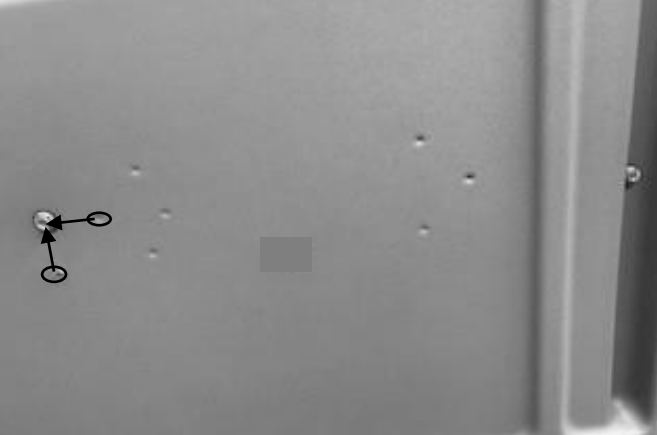

Install “Large Tank option PN 16538” and Vent pipe *continued*:

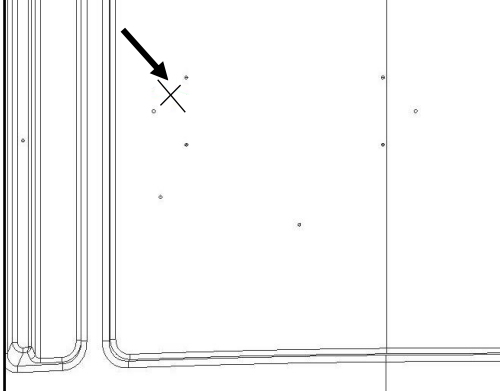
<p>19) Hold tank against panel while installing screws (3) PN 13860 from outside of unit in dimples in left panel shown below using 3/8" (.375") [9.53 mm] Hex Driver bit.</p>	<p>20) Insert vent pipe PN 13796 into tank PN 16538 until it bottoms out against screw.</p>	<p>21) Drive 4th screw PN 13860 through rear panel into dimple in finger groove into tank and vent pipe using 3/8" (.375") [9.53 mm] Hex Driver bit.</p>
		

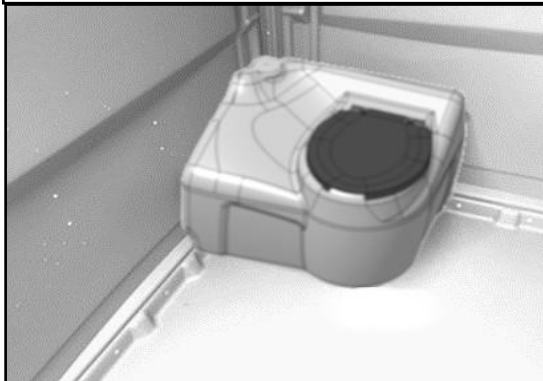
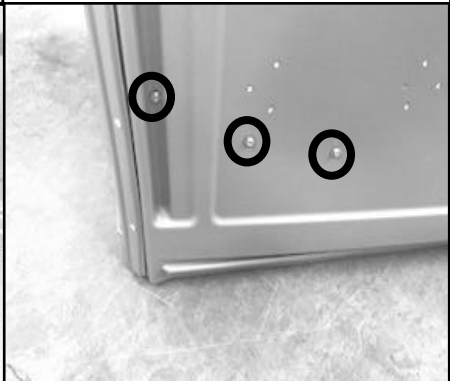
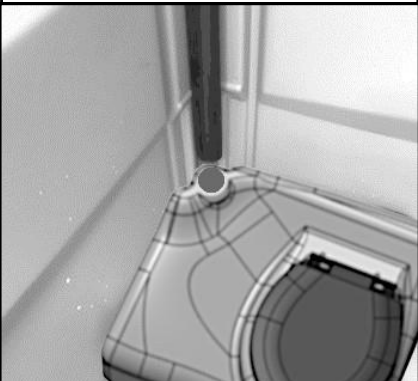

<p>22) Drive 5th screw PN 13860 through rear panel into tank.</p>	<p>NOTE: 5th screw is placed in line with center handle dimple & straight up from dimple as shown on rear panel. Use 3/8" (.375") [9.53 mm] Hex Driver bit.</p>
	

<p>23) Drive 6th screw through “X” rear panel centered between dimples, as shown below. (<i>Right rear corner</i>)</p>	<p>NOTE: 6th screw is centered between dimples in far right rear corner as shown below.</p>
	

Install “35 Gallon Tank Option PN 22608” and Vent pipe:

<p>24) Install seat lid PN 10570 (<i>comes with plastic bolts & nuts</i>) onto tank PN 22608. Install Plastic bolts through seat lid hinges into the tank. Thread plastic nuts on bolts from inside of tank. Position tank in left rear corner of unit.</p>	<p>25) Hold tank against panel while installing (3) screws PN 13860 from outside of unit, through dimples in left panel shown below using 3/8" (.375") [9.53 mm] Hex Driver bit.</p>	<p>26) Insert vent pipe PN 13796 into tank PN 22608 until it bottoms out against screw.</p>
		
<p>27) Drive 4th screw PN 13860 through rear panel into dimple in finger groove to tank and vent pipe using 3/8" (.375") [9.53 mm] Hex Driver bit.</p>	<p>28) Install 5th & 6th screw in dimples rear panel as shown.</p>	
		

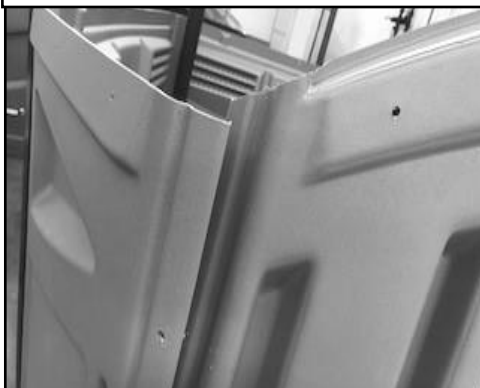
Install Front assembly: STEPS 29 – 36 REQUIRE 2 PERSONS, 1 INSIDE AND 1 OUTSIDE
NOTE: Person inside unit requires- Washers 11315, Washers 22584, Nuts 13131 & 1/2" Wrench.

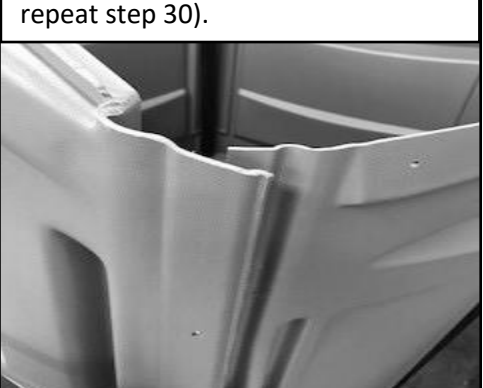
<p>29) Rivet front to half panels. Position left side half panel over left facing of front; align panel holes with holes in left front facing (left side half panel overlaps front left facing).</p>	<p>30) Rivet half panel to front facing using (8) rivets PN 11054 from the outside of panel/front facing with (8) washers P/N 11315 on rivet inside unit.</p>	<p>31) Place right facing of front over right side half panel; align panel holes with holes in facing. (<i>front right facing overlaps right side half panel</i>). Rivet panel to front facing, repeat step 30).</p>
		

Fasten Front assembly to Floor: MAKE SURE GROUND IS LEVEL, FLAT & FREE OF DEBRIS

- 32) (A) Pockets of Front Assembly facings must be over vertical wall of floor.
 (B) The gap between left / hinge facing and ground must be at least .625" [16 mm], IF NOT place .750" [19mm] thick spacer under left facing only, restroom floor must be pushed down tightly against ground.
 (C) The gap between door & right facing of exterior must be parallel and .250" [6 mm] top to bottom. **Adjust if needed by removing shipping screw, adjusting gap and reinstalling shipping screw.**
 (D) The gap between the right facing and the ground should be about .250 [6mm].

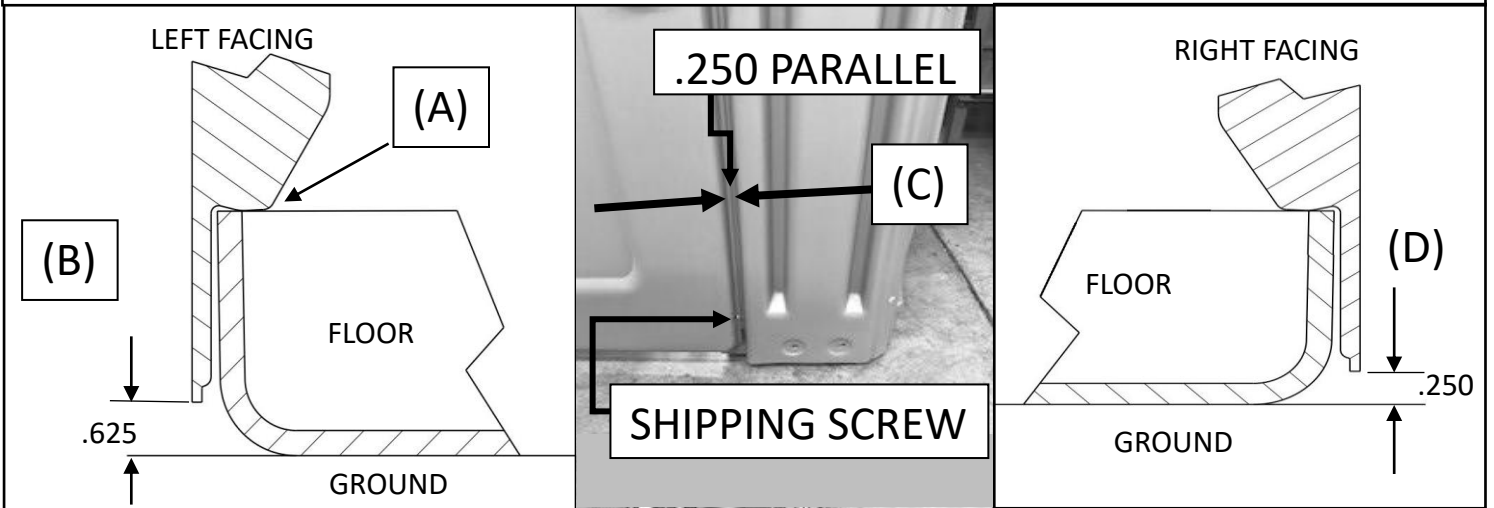

- 33) With the door screwed shut, transfer drill through [5] holes near the bottom of front facings, through floor using 5/16" (.312") [7.64 mm] drill bit.
NOTE: Insert .750 [19mm] thick block under facing if ground to facing gap is less than .625 [16mm].

- 34) Install (5) bolts PN 23870 with (5) washers PN 22584 into the holes

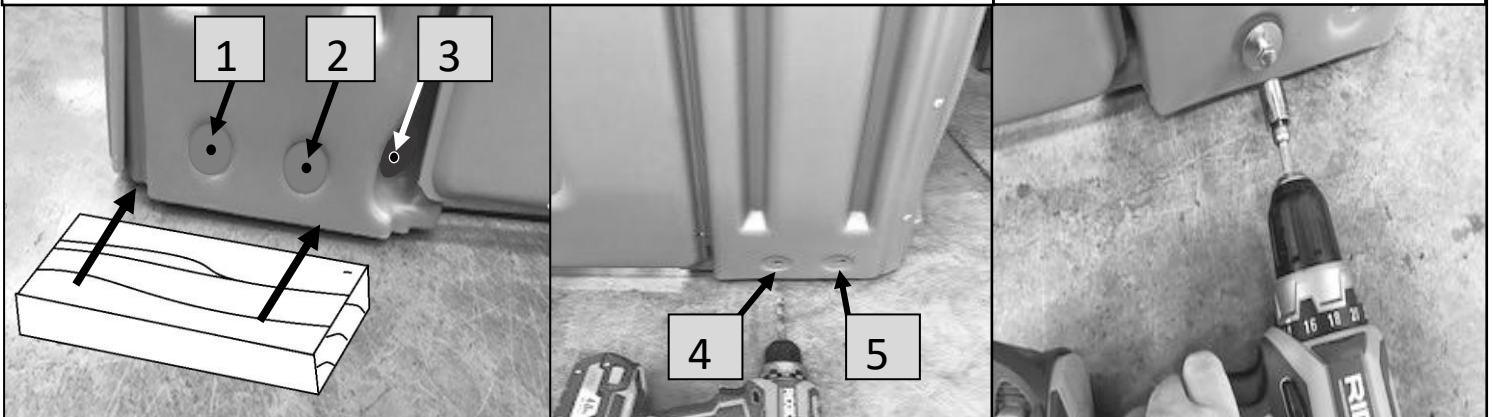

- 35) The person inside restroom installs (5) washers PN 22584 and (5) nuts PN 13131 on bolts. Tighten nuts using 1/2" (.500") [12.7 mm] socket and 1/2" (.500") [12.7 mm] Open end wrench.
****NUTS MUST BE FULLY TIGHTENED, BOLTS PROTRUDING**

- 36) Remove shipping screw, transfer drill the hole that was hidden by door. Install bolt in 6th hole with washers and nut.
NOTE: Allow partner to exit restroom.

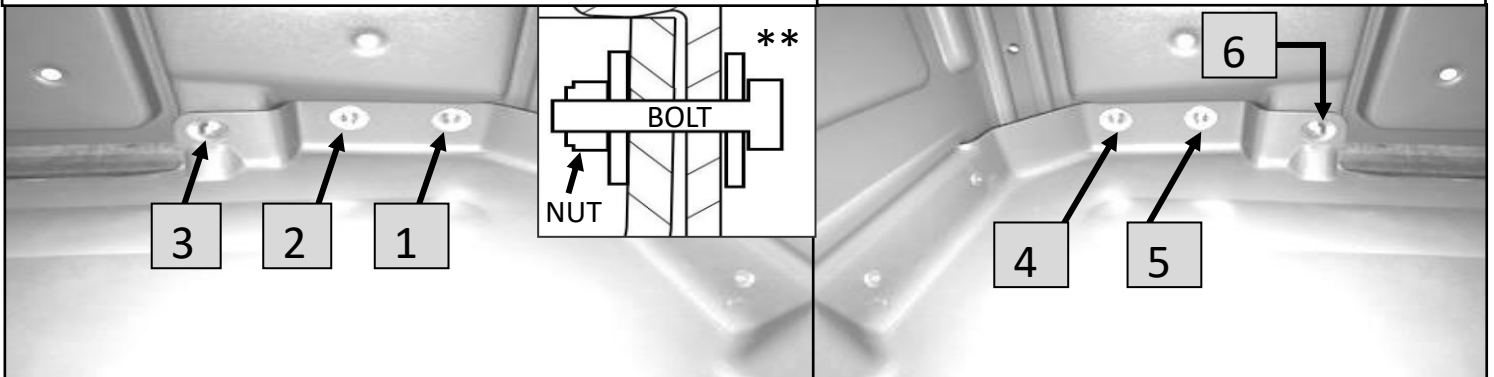

Install Roof:

37) Place roof PN 22518 on unit, with vent pipe hole in left rear corner. Pull roof down over vent pipe. Align holes in roof with holes in panels. Rivet roof to panels using rivets P/N 11054 installed from outside roof & washers PN 11315 inside unit on rivets.



38) Rivet roof to rear panel using (5) rivets P/N 11054 installed from outside of roof & (5) washers P/N 11315 inside unit on rivets.

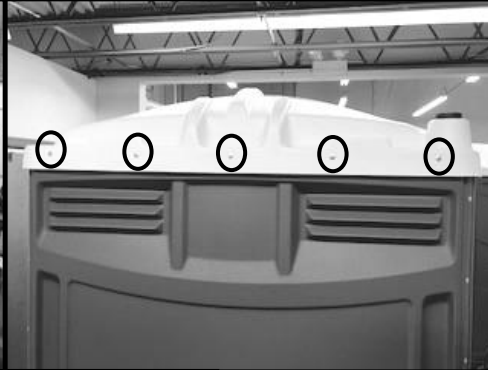

39) Rivet roof to side panels using (8) rivets P/N 11054 per side installed from outside of roof and (8) washers P/N 11315 per side inside unit on rivets.



40) Rivet roof to front door frame. Pull roof down & transfer drill through holes in roof into top door frame facing use #10 (.193") [5 mm] Drill bit. **(DO NOT to drill through 2nd wall of facing)** Rivet roof to front top facing with (6) rivets PN 22604.



Install the Decal:

41) Place Decal PN 10394 on right facing as shown. **NOTE: This area must be clean and dry before applying decal.**

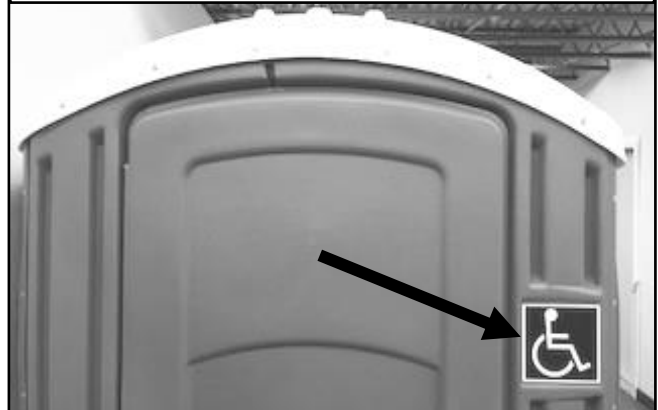

Install Front Hasps:

42) Rivet hasp PN 22605 to door using (2) rivets PN 11270 outside & (2) washers PN 11315 on rivets inside of door. Rivet hasp PN 22605 to facing using (2) rivets PN 11270 outside, & (2) washers PN 11315 on rivets inside of facing.





Install Outside Door Handle:

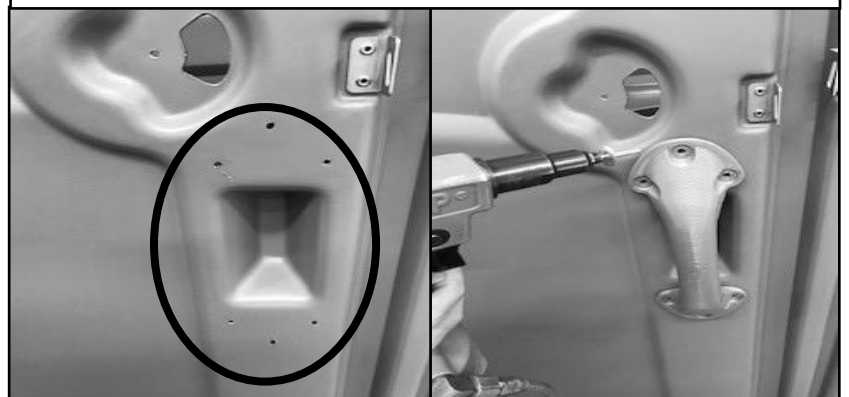

43) Rivet handle PN 22522 on outside of door using (6) rivets PN 22604.

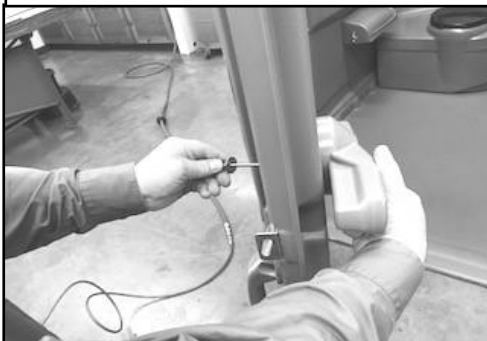

Install door handle / latch:

<p>44) Place handle PN 40057 on inside of door (recessed area). From outside door insert screw 40052 (3-1/2") with washer PN 11360 in hole in door through handle on inside of door.</p>	<p>45) Place washer PN 12382 & nut PN 16307 on screw into recess of handle. Tighten screw/nut using # 3 Phillips Head Driver Bit & 7/16" (.437") socket. Tighten screw/ nut so handle is snug & not so loose that it could fall into closed position.</p>	<p>46) Handle when in open position, green color should be seen in indicator window of door. Red in color when handle is in closed position.</p>
		

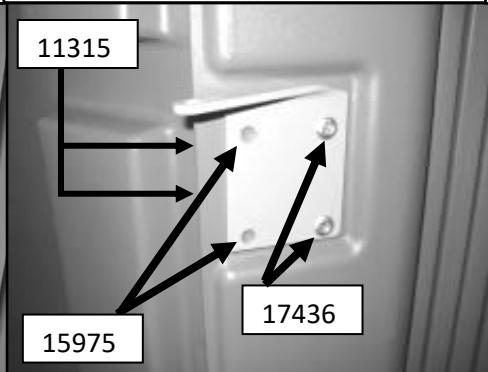
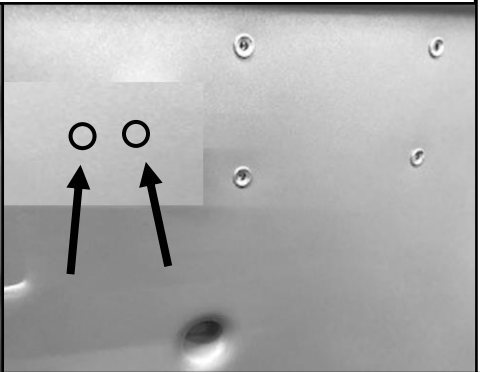
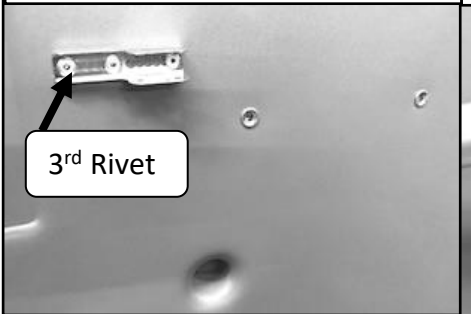
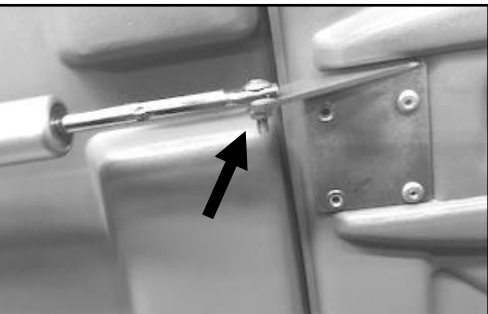
Install Door Closure:

<p>47) Drill at dimples (4) on inside of left facing (pocket for door closure bracket) using #10 (.193") [5 mm] Drill bit. (be careful not to drill through outside wall of left facing or door).</p>	<p>48) Place door closure bracket PN 21382 on facing inside of door as shown. Install (2) rivets PN 17436 in inside holes of bracket. Use (2) rivets PN 15975 in outside holes of bracket & (2) washers PN 11315 on outside</p>	<p>49) Locate & drill out (2) dimples on inside of door to mount door closure bracket to door (included with door closure) using #10 (.193") [5 mm] Drill bit (be careful not to drill through 2nd wall of door).</p>
		
<p>50) Rivet door closure bracket to door (included with door closure). Install bracket completely to the left using (2) rivets PN 17436 Add 3rd rivet far left of bracket, drill hole through bracket into door using #10 (.193") [5 mm] Drill bit.</p>	<p>51) Fasten closure PN 22536 rod to bracket PN 21382. Place rod on top bracket arm. Fasten closure rod to bracket arm with screw PN 18813 and nut PN 20903 use # 2 Phillips Bit & wrench. Just snug screw/nut. DO NOT overtighten, rod must move freely.</p>	<p>52) Attach door closure to bracket on door with pin (provided with closure). NOTE: adjust closure speed by turning cylinder (Instructions for turning direction are on cylinder "small print"). A minimum of 5 seconds required for door to close.</p>
		

Install Door closure cover:

53) Locate 4 inserts on inside of door to mount closure cover.

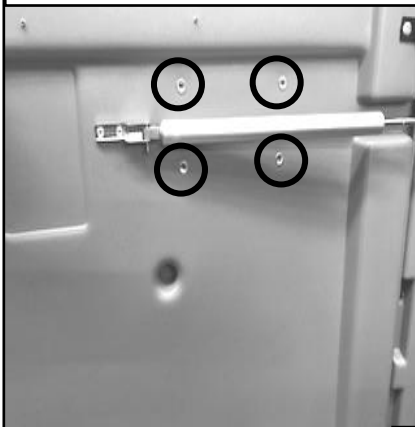

54) Install closure cover PN 22523 with (4) screws PN 18813 Start screws by hand. Then use # 2 Phillips Bit only snug screws in inserts **DO NOT OVERTIGHTEN.**

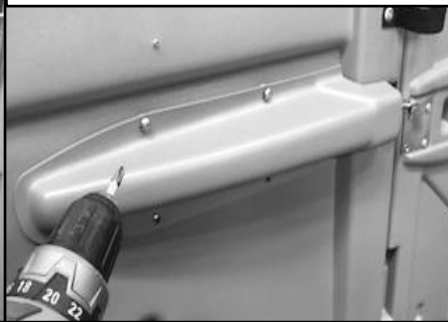

55) Install handle on inside of door: Rivet handle PN 22522 on inside of door using (6) rivets PN 22604.

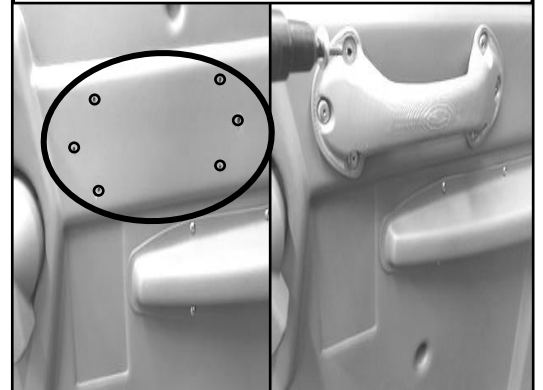

INSTALL GRAB BAR ON REAR PANEL:

56) Drill 5 lower dimple & 5 upper vertical "O" locations shown below use #10 (.193") [5 mm] Drill bit inside of panel.

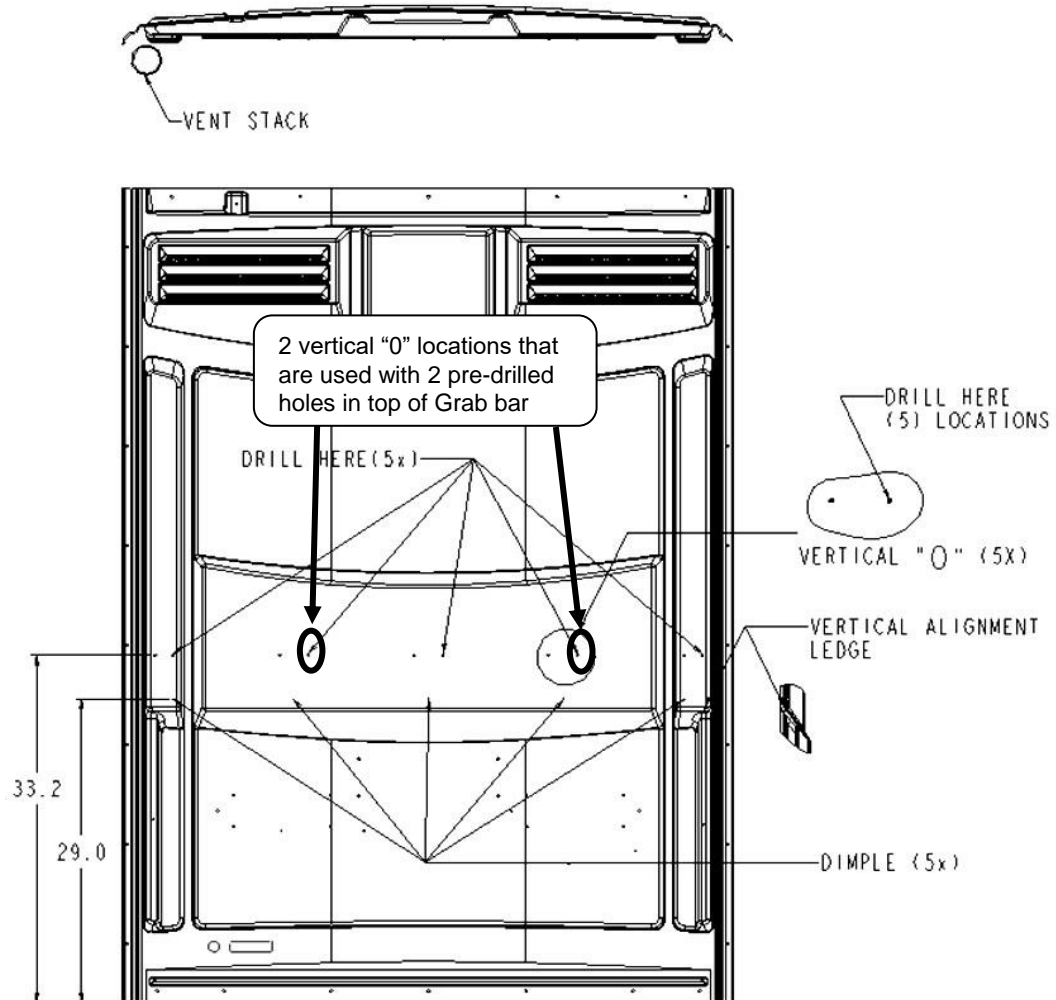

**REAR PANEL
INSIDE VIEW**

INSTALL GRAB BAR ON REAR PANEL *CONTINUED* :

57) "Place Grab Bar on inside of rear panel, make sure bottom of Grab Bar is resting on the vertical alignment ledges 2 per panel, shown above"

From outside of rear panel put (2) rivets PN 22604 into 2 vertical "0" hole locations in rear panel and into the 2 pre-drilled holes in Grab Bar. Then transfer drill into Grab Bar through remaining (8) holes in rear panel, use #10 (.193") [5 mm] Drill bit (**DO NOT drill through 2nd wall of Grab Bar**).

Install (3) rivets PN 22604 with (3) washers PN 11360 in remaining 3 upper holes in rear panel into Grab bar. Install (5) rivets PN 22604 in 5 lower holes in rear panel into Grab Bar as shown below.

2 Predrilled holes in top of Grab Bar align with 2 vertical "0" on rear panel (see previous page).

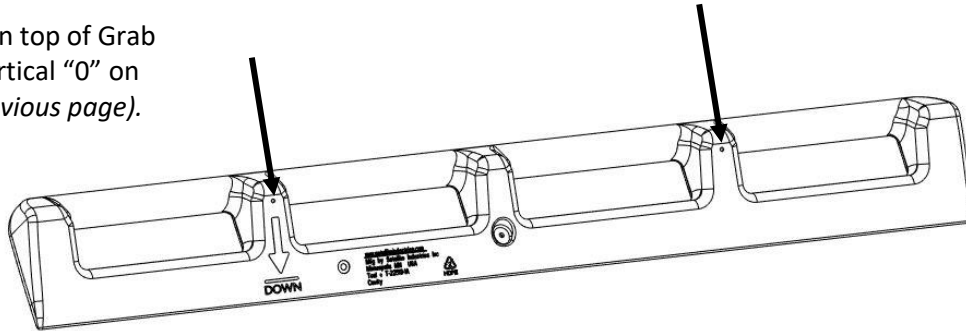

WASHERS

(3) Rivets PN 22604 with Washers PN 11360 in top of grab bar

2 rear panel vertical "0" locations to install rivets in 2 pre-drilled holes in top of Grab bar

5 rear panel lower dimple locations to install rivets in bottom of Grab bar

EXTERIOR OF REAR PANEL

NOTE: INSPECT TGRAB BAR INSTALLATION TO MAKE SURE ALL RIVETS ARE GRIPPING AND INSTALLED PROPERLY.

INSTALL GRAB BAR ON LEFT PANEL:

58) Drill 5 lower dimples & 5 upper horizontal "o" locations shown below. Use #10 (.193") [5 mm] Drill bit on inside of panel.

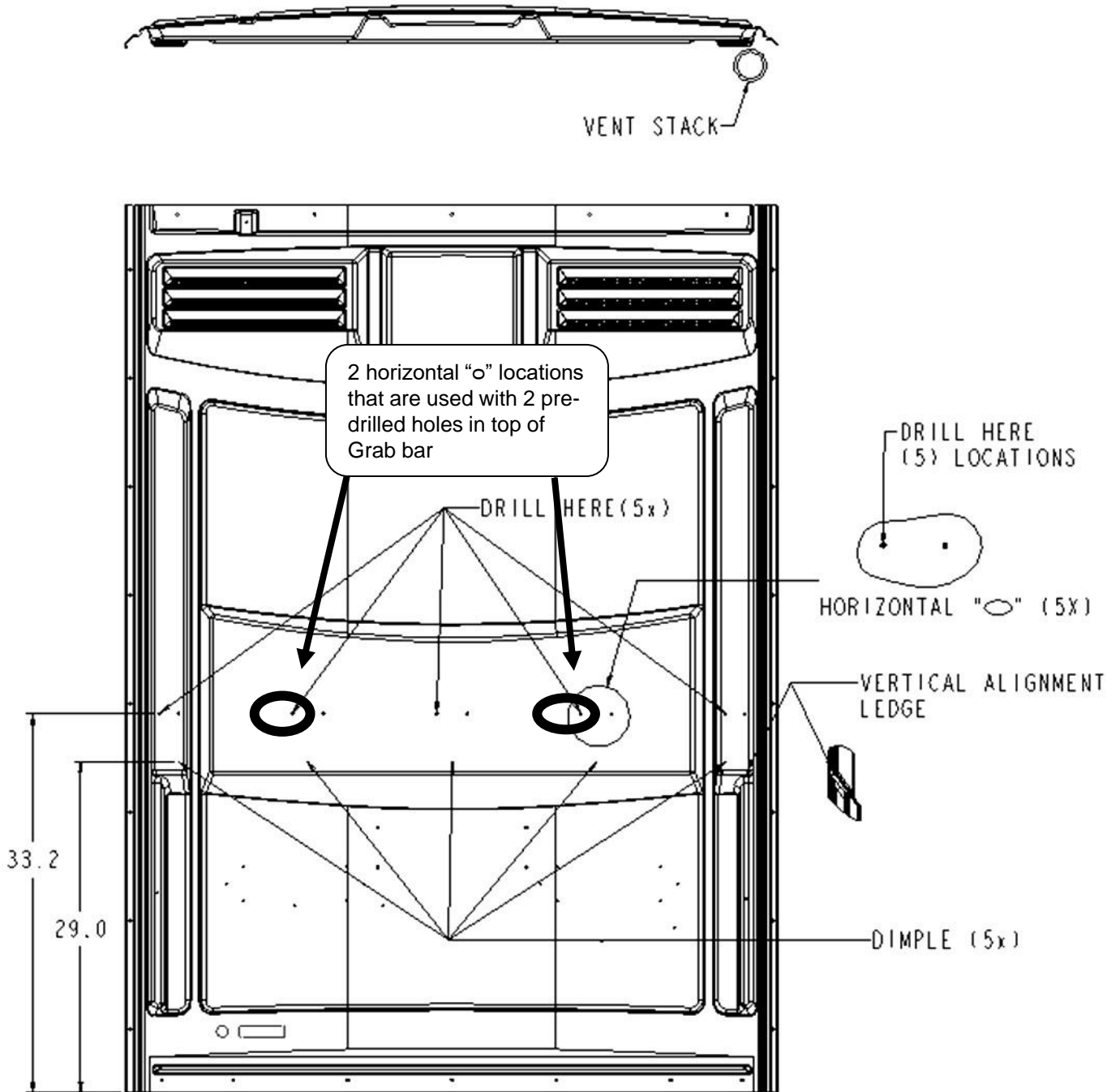

**LEFT PANEL
INSIDE VIEW**

INSTALL GRAB BAR ON LEFT PANEL *CONTINUED* :

59) "Place Grab Bar on inside of left panel, make sure bottom of Grab Bar is resting on vertical alignment ledges 2 per panel, shown above"

From outside of left panel put (2) rivets PN 22604 into 2 horizontal "o" hole locations in left panel and into 2 pre-drilled holes in Grab Bar. Then transfer drill into Grab Bar through remaining (8) holes in left panel, use #10 (.193") [5 mm] Drill bit (**DO NOT drill through 2nd wall of Grab Bar**).

Install (3) rivets PN 22604 with (3) washers PN 11360 in remaining 3 upper holes in left panel into Grab bar. Install (5) rivets PN 22604 in 5 lower holes in left panel into Grab Bar as shown below.

2 pre-drilled holes in top of Grab Bar are in line with 2 horizontal "o" holes noted in left panel.

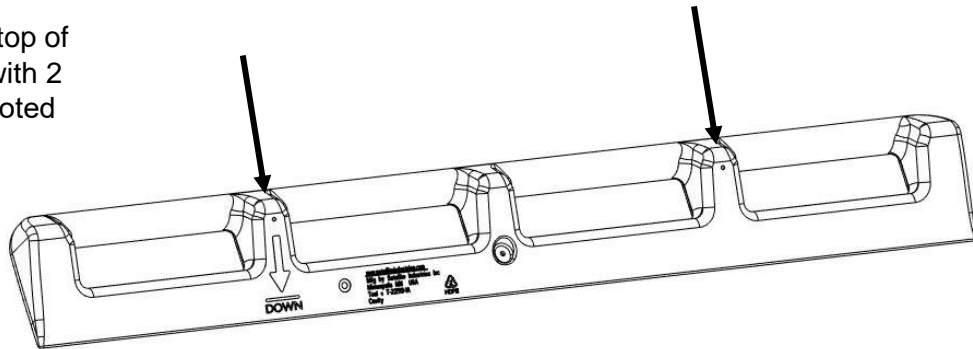

WASHERS

(3) Rivets PN 22604 with Washers PN 11360 in top of grab bar

2 left panel horizontal "o" locations to install rivets in 2 pre-drilled holes in top of Grab bar

5 left panel lower dimple locations to install rivets in bottom of Grab bar

EXTERIOR OF LEFT PANEL

NOTE: INSPECT GRAB BAR INSTALLATION TO MAKE SURE ALL RIVETS ARE GRIPPING AND INSTALLED PROPERLY.



2530 Xenium Lane North, Minneapolis, MN 55441
Telephone: 763-553-1900 Fax: 763-553-1905
800-328-3332 / www.satelliteindustries.com