

# INSTRUCTIONS FOAM SOAP/SANITIZER AND BAG IN BOX DISPENSER INSTALLATION

**INTRODUCTION:** Portable restrooms and accessories must be assembled according to approved assembly procedures. Variations in assembly could adversely affect product life and warranty.

## HARDWARE

- #18431  
HDWE. SOAP/SANITIZER DISPENSER
- #18432 (1)  
INSTRUCTION
- #17436 (3)  
RIVET, AVDEL SILVER
- #11027 (3)  
RIVET, #66 ALUM
- #11315 (3)  
WASHER, 3/16 STNLS

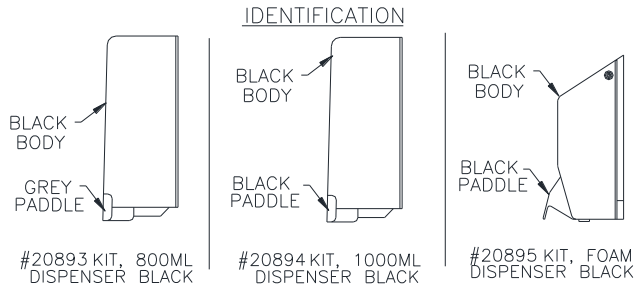

## TOOLS

- Cordless/Electric Drill
  - #10 (0.194") Drill Bit,
  - Rivet Gun
- Open dispenser by inserting key in side of disp on foam disp or push up on bottom button of bag in box dispenser.

**Note:** Be careful to only drill through the inside wall of the panel.

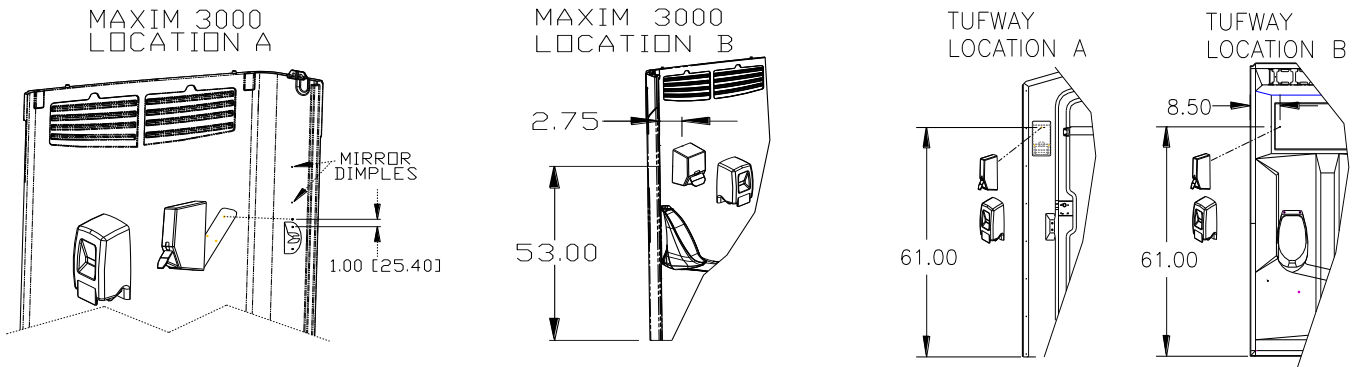

### MAXIM 3000® (Double Wall)

1. Locate upper dimple (See location "A") (Standard Location) for dispenser mounting location on hasp side panel. Drill hole 1" above the dimple using a #10 (0.194") [5mm] drill bit. **(Through First Layer Only)** Use center oblong hole at top of dispenser and rivet to panel using #17436 Rivet. On **800ML, 1000ML or Foam dispenser** use the back plate of dispenser as a template drill out bottom right oblong hole at the top of the oblong hole and fasten with #17436 rivet.
2. **Mounting Above Urinal:** See location "B". Center dispenser above urinal, 53" up from floor to top hole and 2-3/4" from edge of door opening. Fasten through the top center hole in dispenser with #17436 rivet. Using the back plate on **800ML, 1000ML or Foam dispenser** as a template drill out bottom right and left oblong hole at the top of the oblong hole and fasten with #17436 rivet.

### TUFWAY® (Single Wall)

1. **Mounting to Hasp Facing:** See location "A" (Standard Location) for dispenser mounting location. Using the back plate of dispenser on the **Foam, 800ML or 1000ML** dispenser as a template, place on the hasp facing and center 61.00" from the top of the floor to the top hole in the dispenser. Using center top hole of dispenser and a marker, mark top hole location and drill a #10 (0.194") [5mm] **(Through First Layer Only)** and fasten with #17436 Rivet. Then drill out bottom hole on the right and left side of dispenser at the top of the oblong hole and fasten with #17436 rivet.
2. **Mounting Above Urinal:** See location "B" for dispenser mounting location from top of floor 61" and over from front facing 10.00". Fasten dispensers to panel above urinal the same way as hasp facing mounting. Drill all the way through panel and fasten using #11027 rivets and #11315 washers. Insert the rivets from the inside of the dispenser and the washers on the outside of the restroom.

**BREEZE AND WAVE** (See Breeze or Wave picture for dimple location)

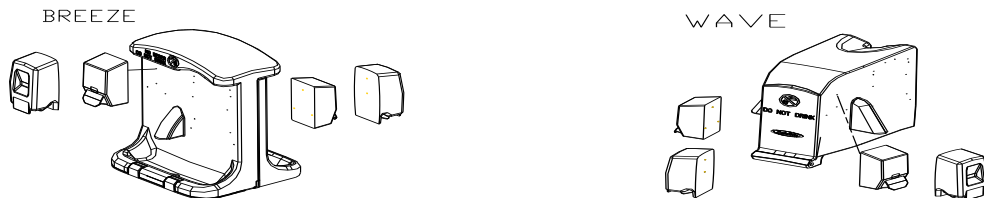

1. **Foam Dispenser:** Drill the (3) dimples with a #10 (0.194) [5mm] drill bit. Fasten with #17436 rivets.
2. **800ML Dispenser:** Drill out top dimple and fasten with #17436 rivet. Using back plate on dispenser as a template drill out bottom hole on the right and left side of dispenser and fasten with #17436 rivet.
3. **1000ML Dispenser:** Drill out top dimple and fasten with #17436 rivet. Using back plate on dispenser as a template drill through right and left bottom oblong hole at the top of the oblong hole and fasten with #17436 rivet.

## Continue INSTRUCTIONS FOAM SOAP/SANITIZER INSTALLATION

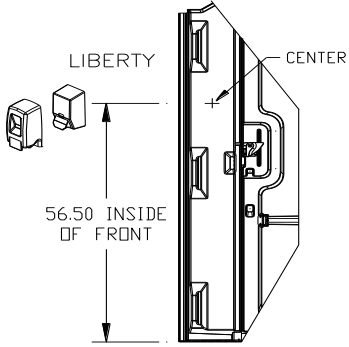

**LIBERTY™**

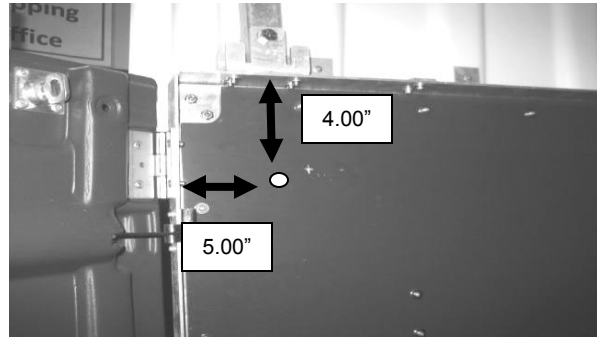

**HIGH RISE™**

- Mounting to Hasp Facing:** See Liberty picture above for dispenser location. Use the same fastening information as the **Tufway Mounting to Hasp facing** instruction for the **Foam, 800ML** and **1000ML** dispenser.

- Mounting to Left panel (top left corner):** Measure down from inside of top angle 4.00" & over from inside of hinge angle 5.00" & mark panel. Drill at mark with #10 (0.194") Drill Bit. This is top mount hole for dispenser, then transfer drill through bottom 2 holes in dispenser mount plate. Rivet dispenser to panel using rivets (3) PN 11027 from outside panel with washers (3) PN 11315 on rivets inside of dispenser mount plate.

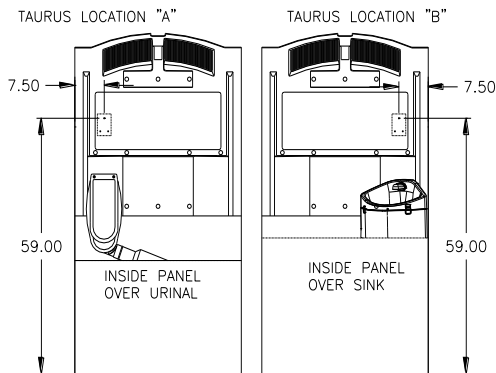
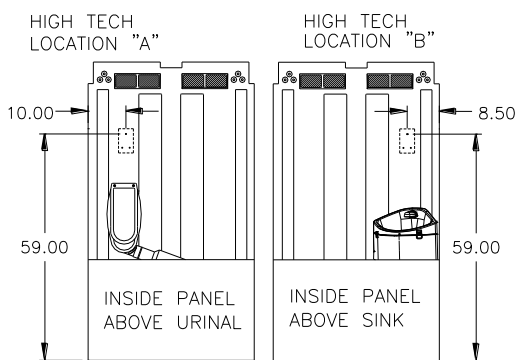



### **HIGH TECH™ (Double Wall)**

- See location "A" (Standard location) for dispenser mounting location from top of floor and over from front facing. Drill a #10 (0.194") [5mm] drill bit (**Through First Layer Only**) and fasten with #17436 rivet. On **Foam, 800ML** and **1000ML** dispenser drill through right and left bottom oblong hole at the top of oblong hole and fasten with #17436 rivets
- Mounting Above Handwash:** See location "B". Fasten dispensers to panel above Handwash the same way as location "A".

### **TAURUS™ (Single Wall)**

- See location "A" (Standard Location) for dispenser mounting location from top of floor and over from front facing. Drill a #10 (0.194") [5mm] hole and fasten with #11027 Rivet and #11315 washer. Then drill through the right and left bottom oblong hole at the top of the oblong hole and fasten with #11027 rivet and #11315 washer. Insert the rivets from the inside of the dispenser and the washers on the outside of the toilet.
- Mounting Above Handwash:** See location "B". Fasten dispensers to panel above Handwash the same way as location "A".

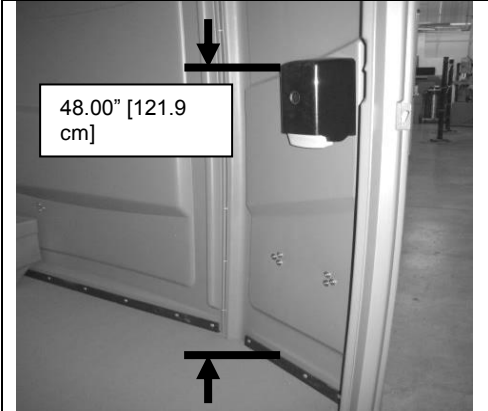
## FREEDOM3®

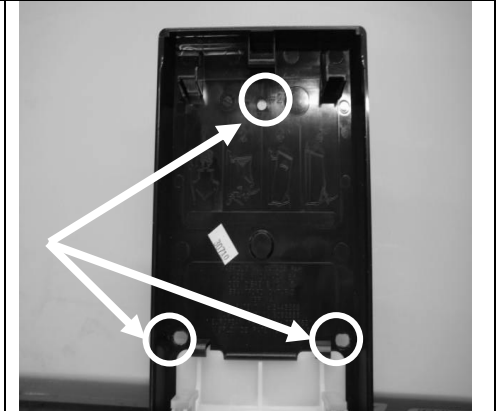
<p>Place dispenser on right facing (hasp side) approximately 48.00" [121.9 cm] from floor to top of dispenser.</p>	<p>Right side of dispenser in line with feature on right facing.</p>	<p>Use back plate of dispenser as a template &amp; drill three holes using # 10 .193" [4.90 mm] drill bit as shown. Rivet dispenser to right facing using (3) rivets PN 11027 on outside of panel &amp; (3) washers PN 11315 on inside of back plate of dispenser Note: hardware is included with dispenser.</p>
		

## GLOBAL™

<p><b>Location "A" HAND SANITIZER / SOAP DISPENSERS</b> Place dispenser with lid open centered on inside of right facing (hasp side) top hole in dispenser up 58.50" [148.6 cm] from floor.</p>	<p><b>Location "B" Soap / Hand sanitizer dispensers</b> place dispenser with lid open on left panel above urinal with top hole in dispenser over 12.00" [30.5 mm] from front facing up 56.00" [142.2 cm] from floor. Fasten to left panel using 3 rivets 11027 from outside of panel &amp; 3 washers PN 11315 on inside of dispenser.</p>
	

# HANDISTAND

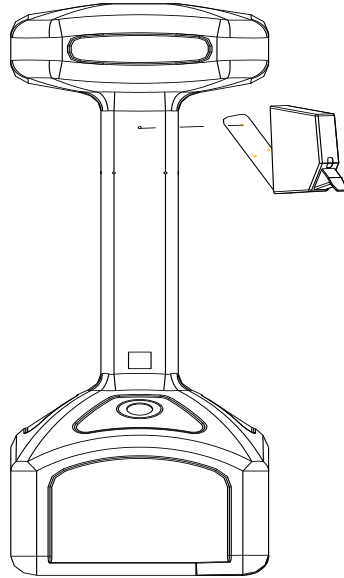

- Dispenser:** Drill out top dimple and fasten with #17436 rivet. Center dispenser using back plate on dispenser as a template drill out bottom hole on the right and left side of dispenser and fasten with #17436 rivets. Repeat on opposed side for the (2) dispenser stand and on all the sides for the (4) dispenser stand.

## BREEZE 2

Location 3 dimples near nozzle of Unit (two sides). Drill out top dimple as shown (two sides) using a # 10 drill bit.

Using #17436 rivet. Rivet dispensers to Breeze 2 at top hole drilled in unit. Use top center hole / slot in dispenser as shown. Hardware kit is included with dispensers.

Make sure dispenser is level & transfer drill through bottom 2 holes / slots through Breeze 2 unit as shown. Rivet dispenser to unit using #17436 rivet.

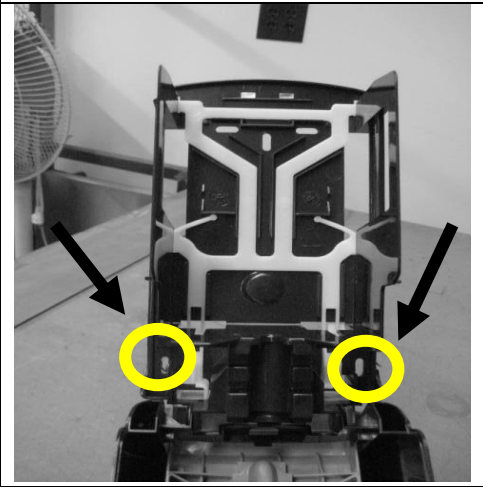
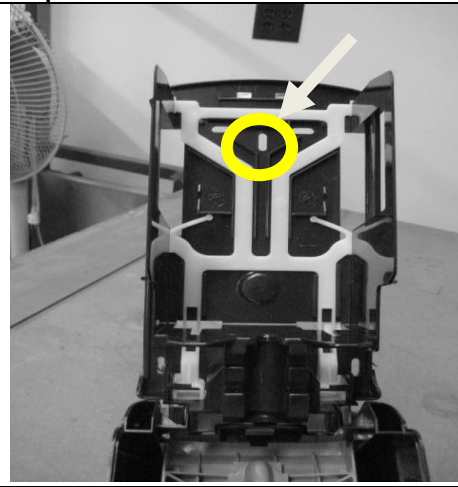

## MAXIM 2000®

**LOCATION "A":** Mark up 61.00" from base floor, centered on hasp facing. Drill at mark with #10 (0.194") [5mm] drill bit (Through First Layer Only) and fasten with #17436 rivet. Then drill out bottom holes on the right and left side of dispenser mount plate at the top of the oblong hole and fasten with #17436 rivet.



**LOCATION "B":** Mark up 59.00" from base on left panel above urinal, over 10.00" from hinge facing. Drill at mark with #10 (0.194") [5mm] drill bit. Fasten with #17436 rivet. Then drill out bottom holes on the right and left side of dispenser mount plate at the top of the oblong hole and fasten with #17436 rivet.

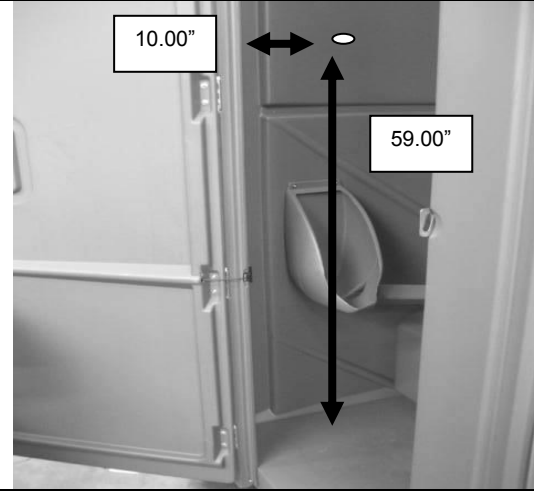

## HIGH TECH II®

Drill at top left of 4 dimples located on left panel right above Handwash using # 10 drill bit [Note: "be careful not do drill through outside wall of panel"]

Open dispenser install rivet PN 17436 in top center hole of dispenser PN 20895 Foaming (need key to open on sides of dispenser, key comes with dispenser) PN 20894 dispenser 1000 ML (press inward on white buttons on bottom of dispenser to open) PN 20893 dispenser 800 ML (press inward on white buttons on bottom of dispenser to open). Hold dispenser level & transfer drill through bottom 2 slots in back mount plate # 10 drill bit. Install rivets (2) PN 17436 & close dispenser cover.

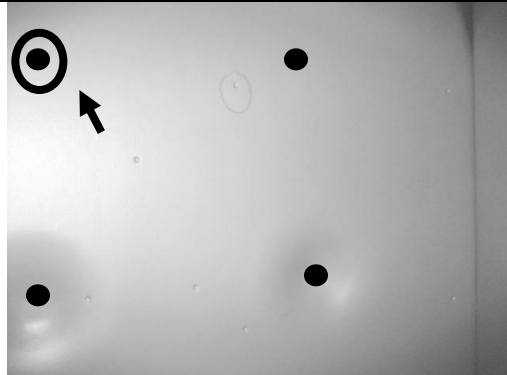

**AGWASH**

Location of 4 inserts to right of nozzle to mount dispensers. **DO NOT DRILL INTO DISPENSER MOUNT AREA OF AGWASH, USE SCREWS INTO INSERTS ONLY.**



**800 ML Dispenser:** locate top insert in Agwash. Use #2 Phillips driver bit to install screw PN 21466 at top center hole / slot in dispenser as shown.

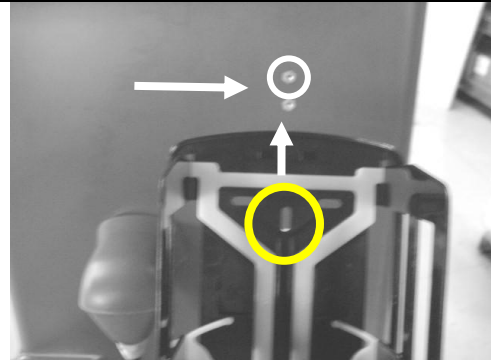

**800 ML Dispenser:** locate bottom 2 inserts. Use #2 Phillips driver bit to install screws (2) PN 21466 in bottom 2 holes / slots in dispenser as shown.

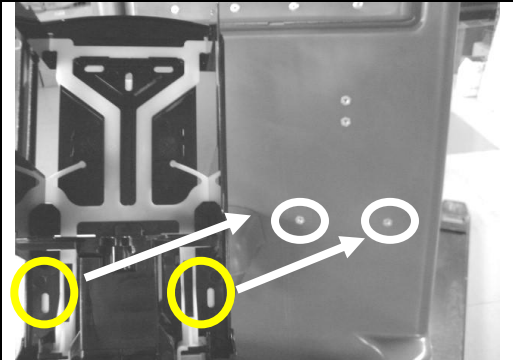

**FOAM DISPENSER:** locate 2<sup>ND</sup> from top insert in Agwash. Use #2 Phillips driver bit to install screw PN 21466 at top center hole / slot in dispenser as shown.

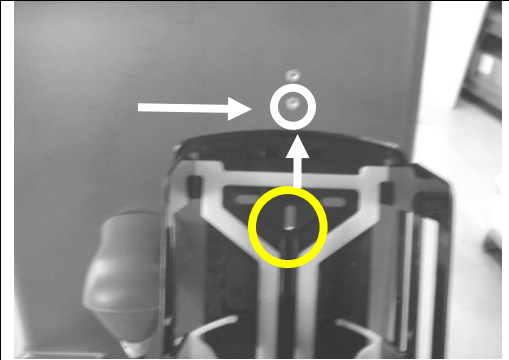

**FOAM DISPENSER:** locate bottom 2 inserts. Use #2 Phillips driver bit to install screws (2) PN 21466 in bottom 2 holes / slots in dispenser as shown.

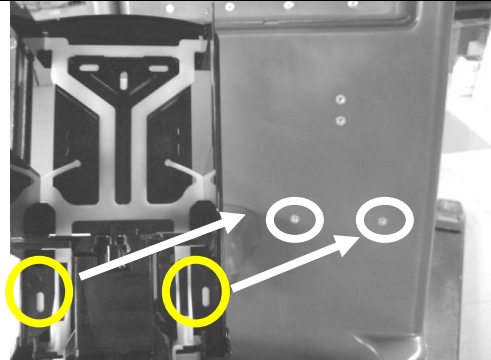

**1000 ML Dispenser:** 1<sup>st</sup> remove backing on bottom 2 tape strips as shown.

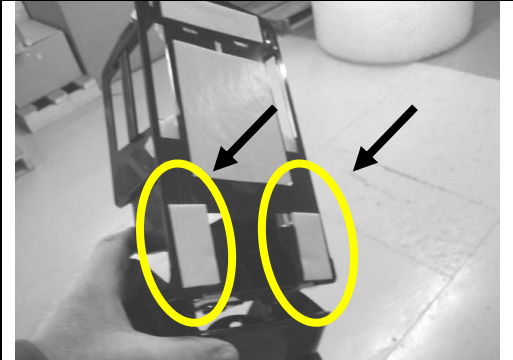

**1000 ML Dispenser:** locate top insert in Agwash. Start screw PN 21466 in center hole / slot in dispenser into insert “do not tighten screw, make sure dispenser is level & press on bottom of dispenser to get tape on back to stick to Agwash”. Use #2 Phillips driver bit to tighten top screw “No screws used in bottom of dispenser”.

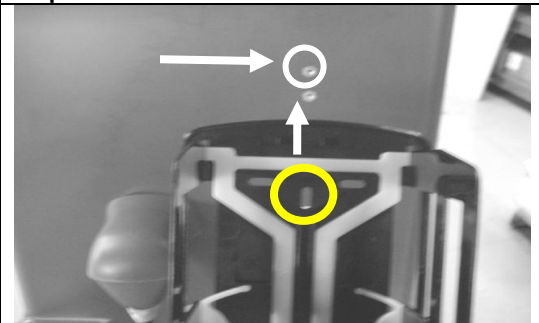

**MAXIM 3000 II (Double Wall)**

**LOCATION "A"** Locate dimple right panel 60.00" up from floor & over 4.50" from finger groove feature in right panel (near where right panel is connected to front).

Drill at dimple on panel (**BE CAREFUL TO DRILL THROUGH INSIDE WALL OF PANEL ONLY**). Rivet dispenser (top hole) to panel using #17436 rivet. Transfer drill through bottom 2 holes & install 2 #17436 rivets.

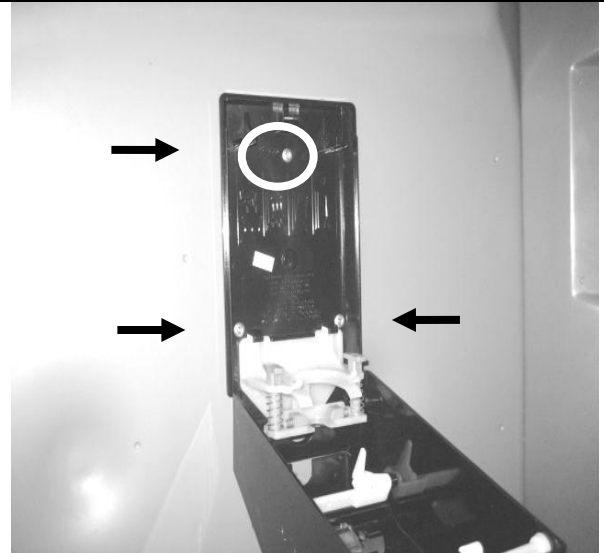

**LOCATION "B"** Mark left panel 60.00" up from floor

Over 4.50" from finger groove feature in left panel (near where left panel is connected to front). Drill at mark on panel (**BE CAREFUL TO DRILL THROUGH INSIDE WALL OF PANEL ONLY**). Rivet dispenser (top hole) to panel using #17436 rivet. Transfer drill through bottom 2 holes & install 2 #17436 rivets.

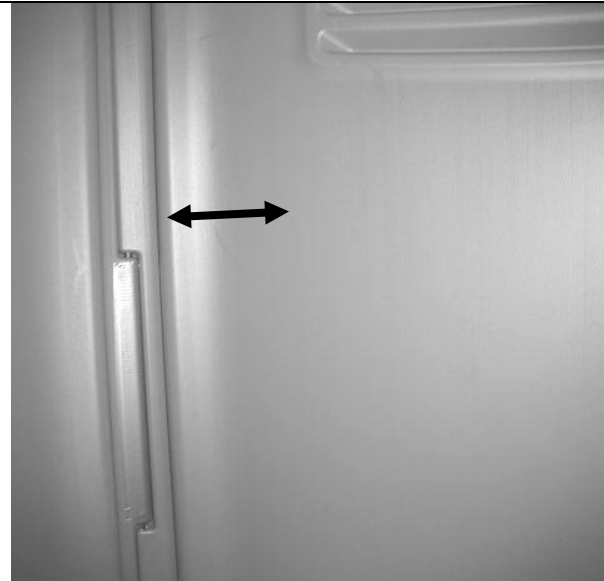
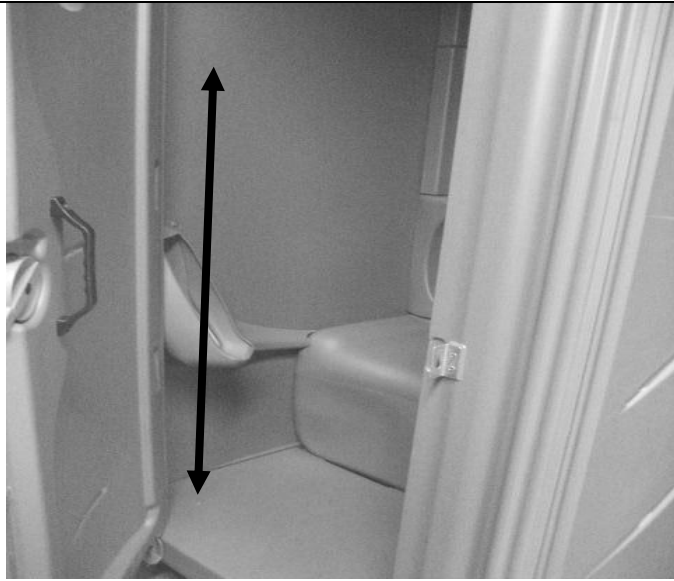

2530 Xenium Lane North, Minneapolis, MN 55441  
Telephone: 763-553-1900 / Fax: 763-553-1905  
800-328-3332/ [www.satelliteindustries.com](http://www.satelliteindustries.com)