

### BREEZE II™ & WAVE II™ TOWEL DISPENSERS

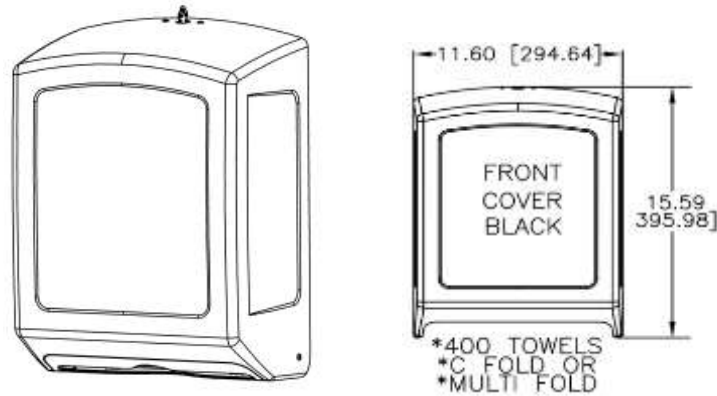

TOWEL DEPTH MAX 4"  
TOWEL WIDTH MAX 10.5"

### SOAP & SANITIZER DISPENSERS

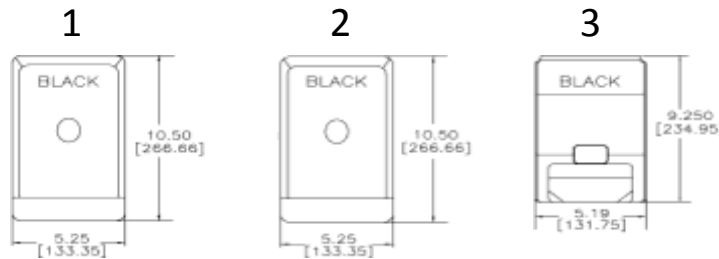

ITEM #	PART#	QTY PER UNIT	DESCRIPTION	PRICE EACH
	21339	2 sink – 1 unit	KIT- DISP P/TOWEL COMBO BLACK (5 PER CASE)	
	18365	2 sink – 1 unit	HDWE- PAPER TOWEL DISPENSER	
1	20893	2 sink – 1 unit	KIT- 800ML DISPENSER (EA) BLACK (12 PER CASE) (20890)	
2	20894	2 sink – 1 unit	KIT- 1000ML DISPENSER (EA) BLACK (12 PER CASE) (20981)	
3	20895	2 sink – 1 unit	KIT- FOAM DISPENSER (EA) BLACK (15 PER CASE) (20982)	
	18431	2 sink – 1 unit	HDWE- SOAP/SANITIZER DISPENSER	

### SOAP & SANITIZER FOR DISPENSERS

USE W/ITEM#	PART#	DESCRIPTION
1	19327	REFILL- H SANIT 800ML 12/C IPK (LIGHT GREEN)
1	19325	REFILL- SOAP 800ML 12/CS IPK (PINK)
2	19328	REFILL- H SANIT 1000ML 6/C IPK (LIGHT GREEN)
2	19326	REFILL- SOAP 1000ML 10/CS IPK (PINK)
3	18371	REFILL- FOAM SANIT 1L 8/CS (PURPLE)
3	18370	REFILL- FOAM SOAP 1L 6CS (LIGHT BLUE)
3	19009	REFILL- GEL ALCH SANI 1L 8/CS (GREEN)

## CONTAINMENT TRAY

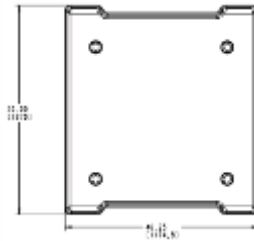

REV A ITEM #	PART#	QTY PER UNIT	DESCRIPTION	PRICE EACH
	22410	1	TRAY- CONTAINMENT II	CALL

## 10" MANWAY KIT Pre-Fall 2016

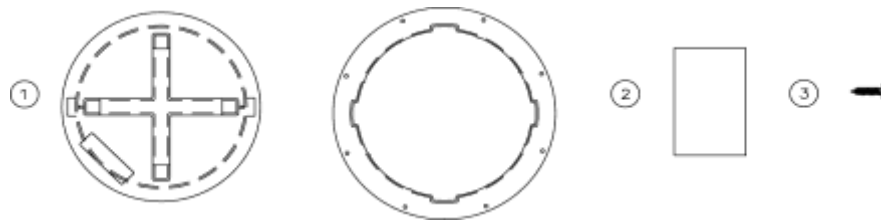

REV B ITEM #	PART#	QTY PER UNIT	DESCRIPTION	PRICE EACH
	18120		KIT- 10in PLASTIC MANWAY (For holding tanks item#18056 & 18055)	
1	18118	1	CAP/RING ASSY- 10in PLS MANWAY	
2	18119	1	INSTRUCTIONS- 10" PLSTC MANWAY	
3*	10122	8	SCREW- #10 X 3/4 PHPN TAP PLTD	



REV B ITEM #	PART#	QTY PER UNIT	DESCRIPTION	PRICE EACH
	22477	2 Per Tank	KIT- 3" SPIGOT 250 GALLON TANK (For holding tanks fall 2016 to present)	
1	22448	1	ADAPTER- 3" FPT X3" SPIGOT PVC	
2	22447	1	GASKET- 3" UNISEAL ADAPTER	
3	22468	1	INSTR- 250G TNK 3" SPIGOT ASSY	
4	22449	1	PLUG- 3" MIPT PVC	

## HOLDING TANK MAJOR ASSEMBLY

### Fall 2016

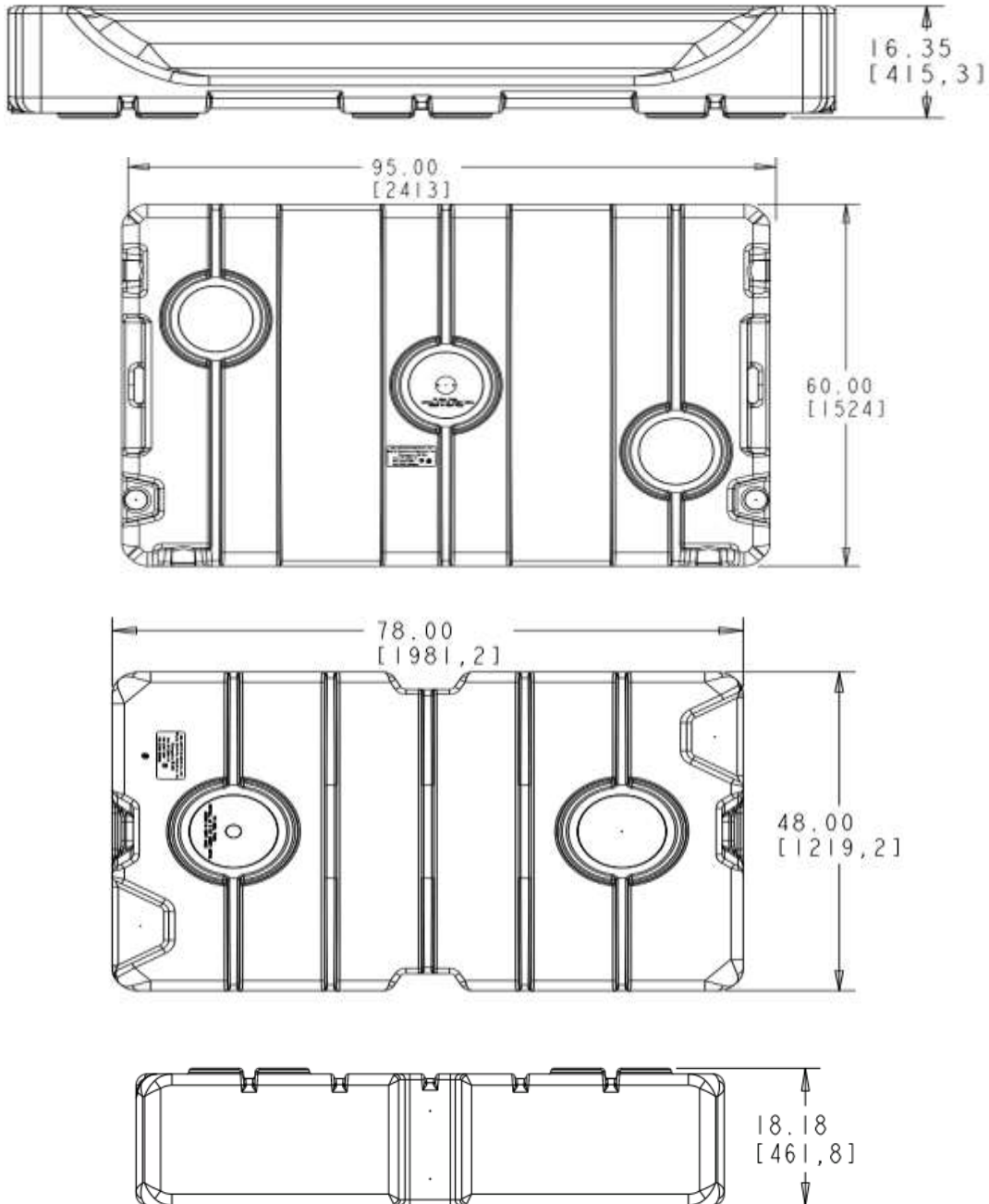

REV B ITEM #	PART#	QTY	DESCRIPTION	PRICE EACH
	22394	1	HOLDING TANK - 300GAL DGRY II	CALL
	22395	1	HOLDING TANK - 300GAL NAT II	CALL
	22417	1	HOLDING TANK- 250 GAL DGRY (May need Kit item#22477)	CALL
	22418	1	HOLDING TANK - 250 GAL NAT (May need Kit item#22477)	CALL

Consult your Area Manager at:  
 Tel: 1-800-883-1123 (US & Canada) Fax: 1-800-328-3334 (US & Canada) Español: 1-877-452-1187  
 Website: [www.satelliteindustries.com](http://www.satelliteindustries.com)

TOOLS

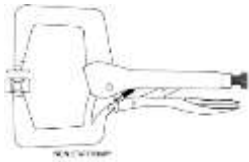

11593



17435

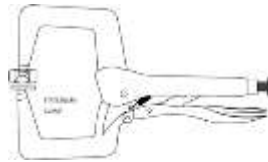

14402

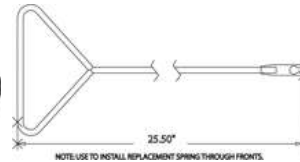

19008

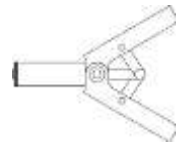

15814

REV	PART#	DESCRIPTION	PRICE EACH
D	11593	CLAMP- NON-STATIONARY PUSH CAP	
B	14402	CLAMP- STATIONARY PUSH CAP	
A	15814	TOOL- PLSTC EXPND RIVET INSALL	
B	14331	INSERT- 1/4-20 JACK NUT	
B	14332	WRENCH- JACK NUT	
C	10089	BOLT- 1/4-20 X 1 GR5 PLTD	
A	17435	BIT- T30 TORX	
A	19008	TOOL- CLOSURE SPRING INSTALL	

PADLOCKS

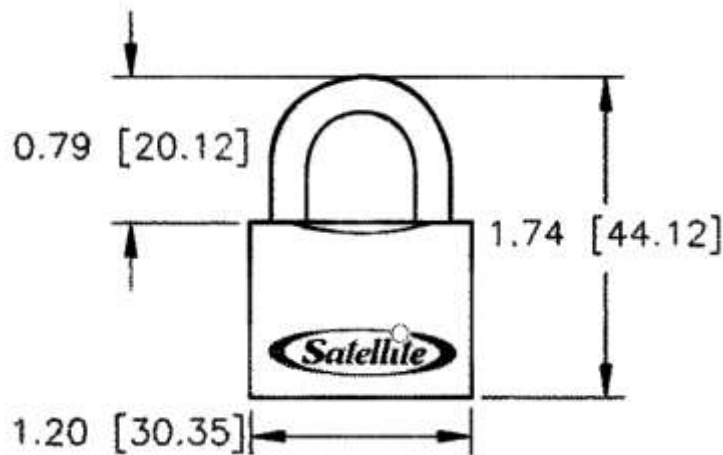

REV D ITEM#	PART#	DESCRIPTION	PRICE EACH
	14551	PADLOCK- 30MM SATELLITE (12 PER BOX)	
	21764	KEY- PADLOCK 30MM SATELLITE	

### SOLAR LIGHT LUNGARGLO

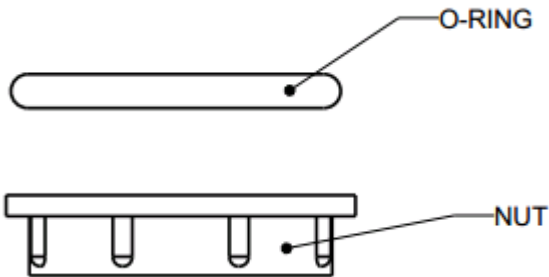
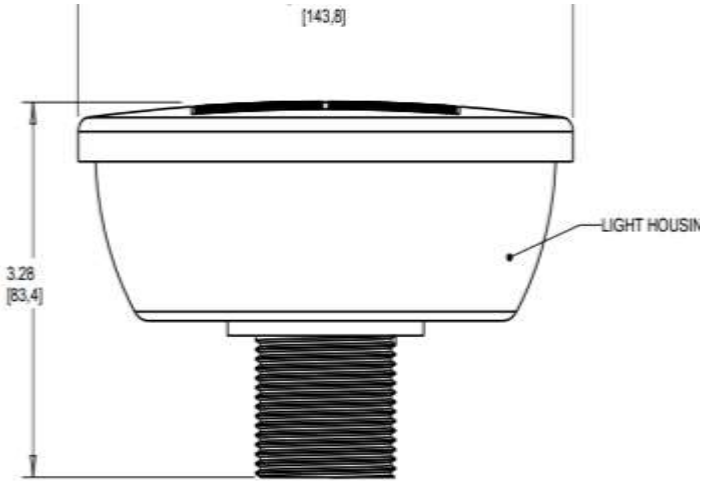

REV A ITEM #	PART#	QTY PER UNIT	DESCRIPTION	PRICE EACH
	22090	1	SOLAR LIGHT- LUNARGLO	

DECAL REFERENCE CHART

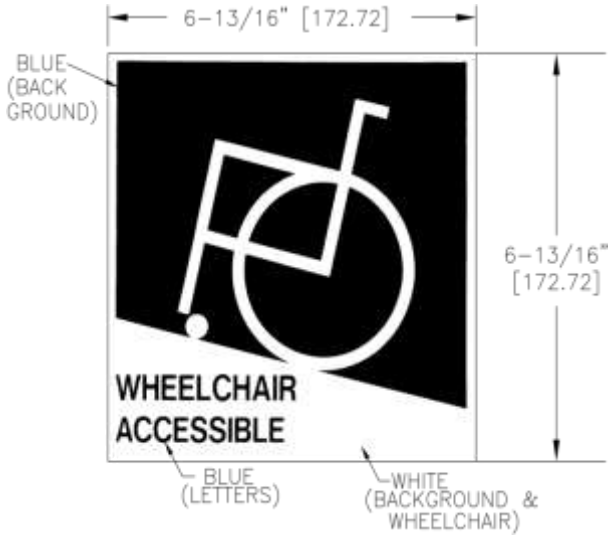

14401 DECAL LIBERTY

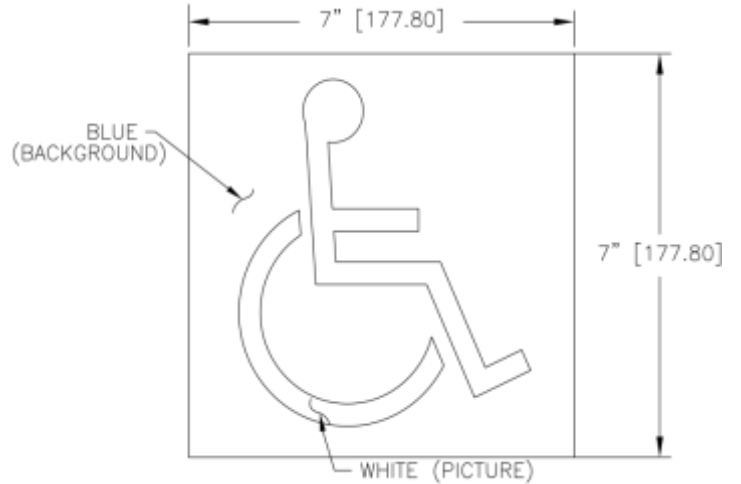

10394 DECAL ISA  
FREEDOM2

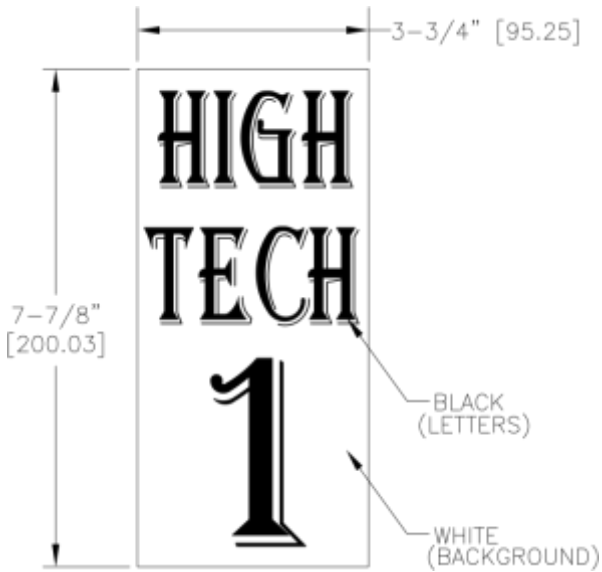

18720 DECAL HIGH TECH 1



21150 DECAL FOOT FLUSH

DECAL REFERENCE CHART

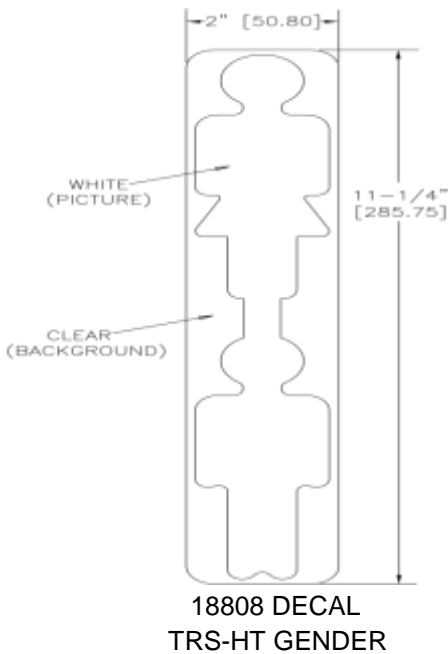
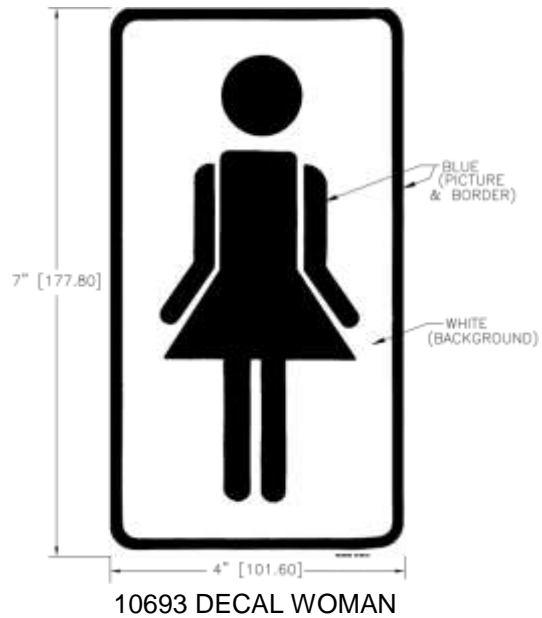
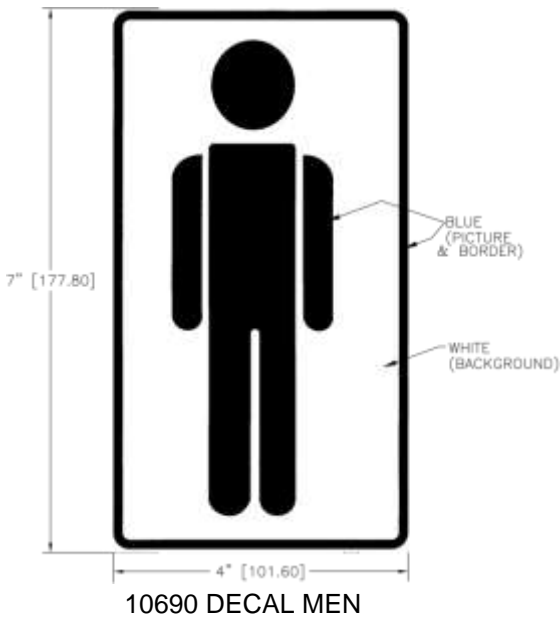

**Maxim 3000® Wet Lift**

- \* Lift kit must contain the following parts:  
 (2) Turn Buckles (1) Spreader Bar  
 (4) 1/8" x 104.5" cables w/ threaded ends  
 (1) Top Lift Cable Assembly (8) Inserts w/screws  
 (4) 5/16" x 2.5" bolts w/washers (1) Wire Tie
- \* Maximum allowable lifting weight; 1,072 lbs/487 kg
- \* **WARNING;** Customer assumes all responsibility for damages if unit is lifted more than the maximum allowable weight
- \* Customer assumes all responsibility if anything other than Satellite approved components are used for lifting
- \* **DO NOT** lift unit with person inside
- \* **DO NOT** lift unit over people
- \* Cables should be checked for tightness before usage, if loose, tighten using turnbuckles at bottom of unit
- \* Inspect for damage and wear before lifting and always use safe lifting practices
- \* **DO NOT** leave unit hanging for more than two (2) hours

#17155 Rev. D

17155 DECAL MX3 WET LIFT WARNING

DECAL REFERENCE CHART

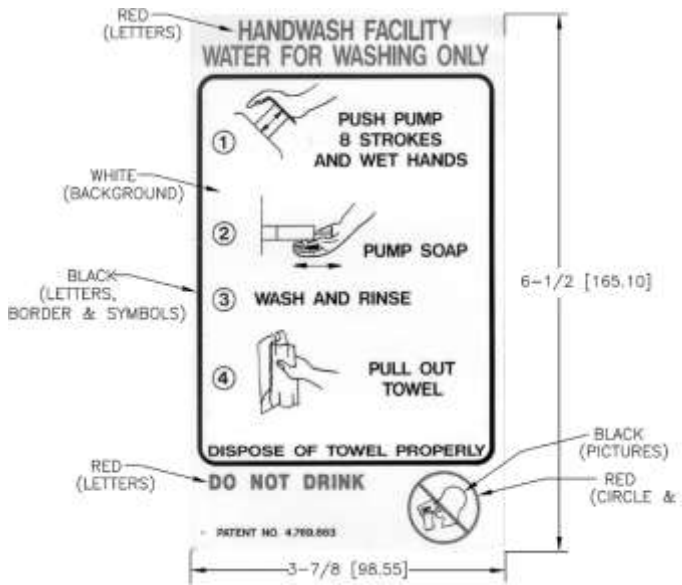

13464 DECAL HANDWASH INSTRUCTIONS

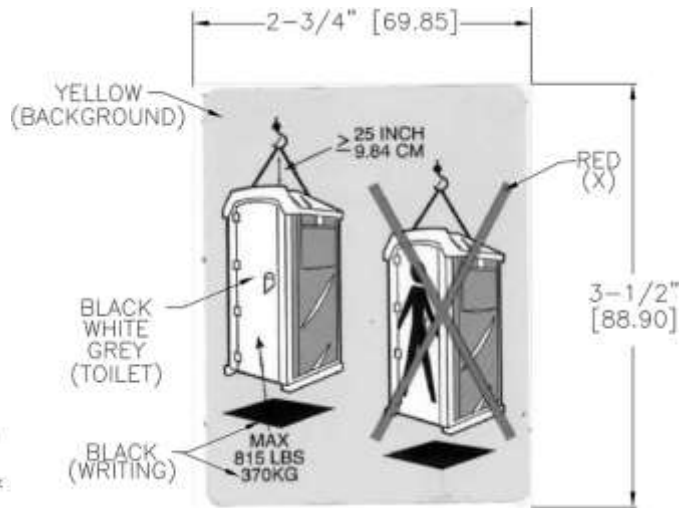

15049 DECAL MX2 WET LIFT

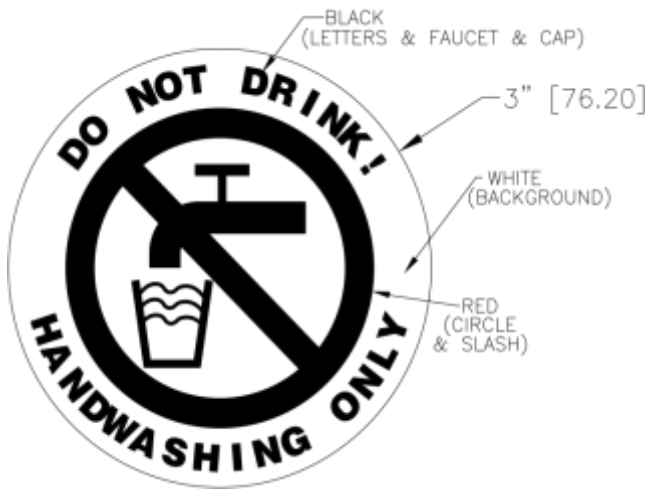

13776 DECAL DO NOT DRINK

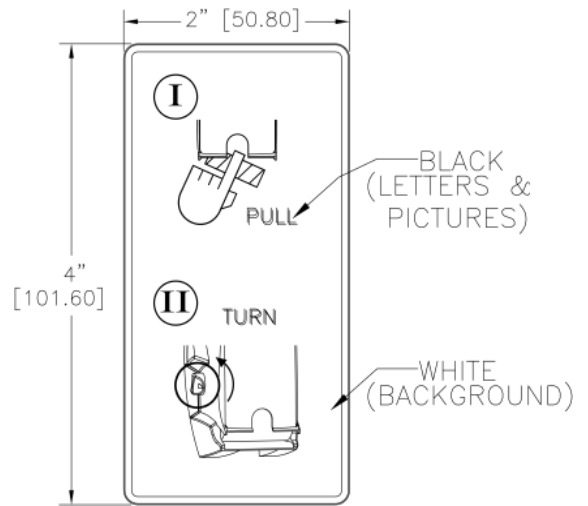

19308 DECAL 4 ROLL TP DISPENSER



DECAL REFERENCE CHART

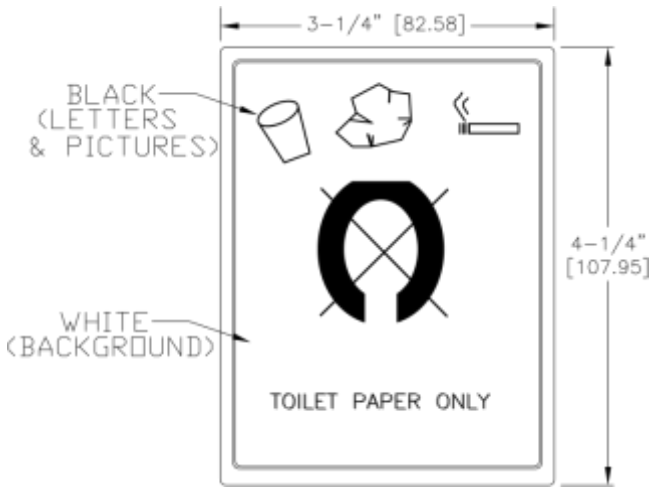

19260 DECAL  
TOILET PAPER ONLY

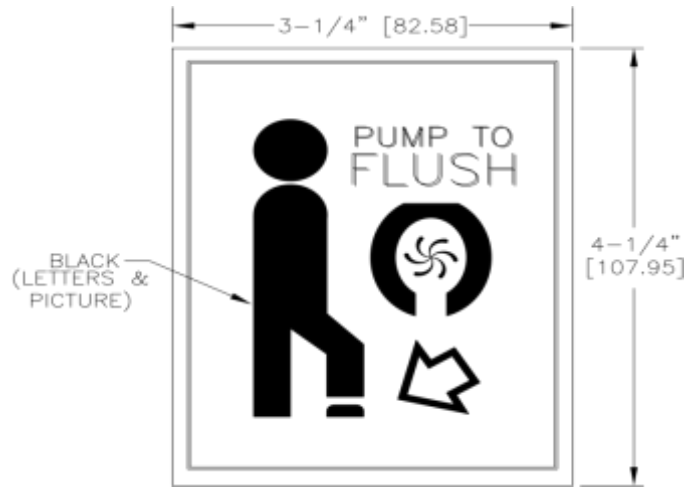

19259 DECAL  
HT2 FLUSH INSTRUCTIONS



21151 DECAL FLUSHING UNIT



21083 DECAL HANDISTAND

DECAL REFERENCE CHART



17318 DECAL  
ICON LUXURY FLUSH & WASH

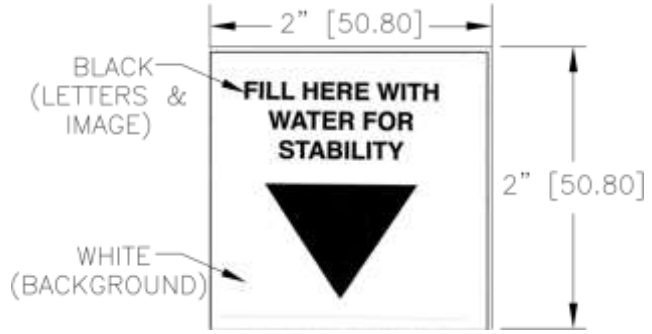

20889 DECAL  
HANDISTAND STABILITY

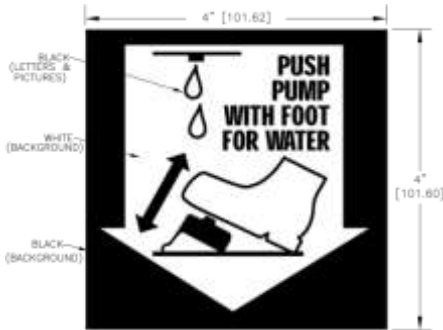

17463 DECAL  
WAVE / BREEZE

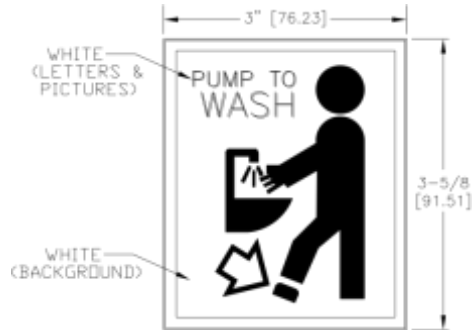

18995 DECAL  
HT2 HAND WASH

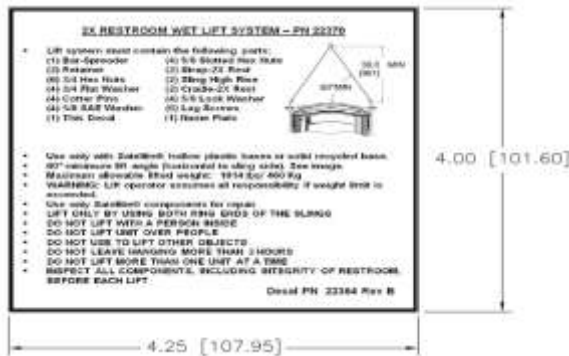

22364 Decal  
2X Wet Lift